

IMX 7 Series

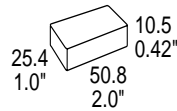

Wide input voltage ranges up to 150 V DC
1 or 2 outputs up to 48 V DC
1500...2500 V DC I/O electric strength test

- Extremely wide input voltage ranges
- Electrical isolation, also between outputs
- Emissions below EN 55 022 level B.
- Immunity to IEC/EN 61000-4-2, -3, -4, -5 and -6
- High efficiency (typ. 84%)
- Inhibit input, output voltage adjustable
- Flex power: flexible load distribution on outputs
- Outputs no-load, overload and short-circuit proof
- Operating ambient temperature up to -40...85°C
- High reliability and no derating
- 2" x 1" case with 10.5 mm profile
- Supplementary insulation

Safety according to IEC/EN 60950, UL 1950



¹ For 70/110 IMX types

Summary

The IMX 7 series of board mountable 7 Watt DC-DC converters has been designed according to the latest industry requirements and standards. The converters are particularly suitable for use in mobile or stationary applications in transport, railways, industry or telecommunications where variable input voltages or high transient voltages are prevalent.

Covering a total input voltage range from 8.4 V DC up to 150 V DC with four different types the units are available with single and electrically isolated double outputs allowing the configuration of output voltages from 3.3 V DC up to 48 V DC externally adjustable, with flexible load distribution on double output units. An inhibit input allows remote converter on/off.

Features include efficient input and output filtering with unsurpassed transient and surge protection, low output ripple and noise, consistently high efficiency over the entire input voltage range, high reliability as well as excellent dynamic response to load and line changes.

The converters provide supplementary insulation with SELV outputs as e.g. required in battery supported systems where the bus voltage may exceed the SELV limit of

60 V DC. They are designed and built according to the international safety standards IEC/EN 60950, UL 1950, CAN/CSA C22.2 No.950-95 and are LGA and UL marked. The 70 IMX 7 and 110 IMX 7 types are CE marked.

The circuit comprises of integrated planar magnetics and all components are automatically assembled and solidly soldered onto a single PCB without any wire connections. Magnetic feedback ensures maximum reliability and repeatability in the control loop over all operating conditions. Careful considerations of possible thermal stresses ensure the absence of hot spots providing long life in environments where temperature cycles are a reality. The thermal design allows operation at full load up to an ambient temperature of 85°C in free air without using any potting material. For extremely high vibration environments the case has holes for screw mounting.

Various options such as extended temperature range -40...85°C an uncased low profile version provide a high level of application specific engineering and design-in flexibility.

Table of Contents

	Page		Page
Summary	1	Auxiliary Functions	19
Model Selection	2	Electromagnetic Compatibility (EMC)	11
Part Number Description	3	Immunity to Environmental Conditions	12
Functional Description	3	Mechanical Data	13
Electrical Input Data	4	Safety and Installation Instructions	14
Electrical Output Data	6	Description of Options	15

Model Selection

Table 1: Part Number Descriptions

Output 1		Output 2		Output Power	Input voltage range	Efficiency	Type designation	Options ²
$U_{o1\ nom}$ [V DC]	$I_{o1\ nom}$ [A] ¹	$U_{o2\ nom}$ [V DC]	$I_{o2\ nom}$ [A] ¹	$P_{o\ nom}$ [W]	[V DC]	η_{typ} [%]		
3.3	1.5	-	-	5	8.4 - 36	79	20 IMX 7-03-9	-8, Z
3.3	1.5	-	-	5	16.8 - 75 ³	81	40 IMX 7-03-9	-8, Z
3.3	1.5	-	-	5	40 - 121	79	70 IMX 7-03-9	-8
3.3	1.5	-	-	5	60 - 150	79	110 IMX 7-03-9	-8
5.1	1.2	-	-	6.1	8.4 - 36	80	20 IMX 7-05-9	-8, Z
5.1	1.2	-	-	6.1	16.8 - 75 ³	81	40 IMX 7-05-9	-8, Z
5.1	1.2	-	-	6.1	40 - 121	80	70 IMX 7-05-9	-8
5.1	1.2	-	-	6.1	60 - 150	80	110 IMX 7-05-9	-8
5	0.6	5	0.6	6	8.4 - 36	82	20 IMX 7-05-05-9	-8, Z
5	0.7	5	0.7	7	16.8 - 75 ³	83	40 IMX 7-05-05-9	-8, Z
5	0.7	5	0.7	7	40 - 121	82	70 IMX 7-05-05-9	-8
5	0.7	5	0.7	7	60 - 150	82	110 IMX 7-05-05-9	-8
12	0.25	12	0.25	6	8.4 - 36	84	20 IMX 7-12-12-9	-8, Z
12	0.3	12	0.3	7.2	16.8 - 75 ³	84	40 IMX 7-12-12-9	-8, Z
12	0.3	12	0.3	7.2	40 - 121	83	70 IMX 7-12-12-9	-8
12	0.3	12	0.3	7.2	60 - 150	84	110 IMX 7-12-12-9	-8
15	0.2	15	0.2	6	8.4 - 36	84	20 IMX 7-15-15-9	-8, Z
15	0.24	15	0.24	7.2	16.8 - 75 ³	84	40 IMX 7-15-15-9	-8, Z
15	0.24	15	0.24	7.2	40 - 121	83	70 IMX 7-15-15-9	-8
15	0.24	15	0.24	7.2	60 - 150	84	110 IMX 7-15-15-9	-8
24	0.13	24	0.13	6.2	8.4 - 36	84	20 IMX 7-24-24-9	-8, Z
24	0.15	24	0.15	7.2	16.8 - 75 ³	84	40 IMX 7-24-24-9	-8, Z
24	0.15	24	0.15	7.2	40 - 121	83	70 IMX 7-24-24-9	-8
24	0.15	24	0.15	7.2	60 - 150	84	110 IMX 7-24-24-9	-8

¹ Flexible load distribution on double outputs possible.

² For single output models it is recommended to parallel the two outs of dual unit.

³ Operation at lower input voltage possible: P_o approx. 80% of $P_{o\ nom}$ at $U_{i\ min} = 14.4$ V.

Part Number Description

Input voltage range V_i

8.4 - 36 V DC	20
16.8 - 75 V DC	40
40 - 121 V DC	70
60 - 150 V DC	110

Series IMX 7

Output voltage type output 1 03, 05, 12, 15, 24

Dash: Designates double output unit with two independent electrically isolated outputs

Output voltage type output 2 05, 12, 15, 24

Operating ambient temperature range T_A

-40 to 71 °C	-9
-40 to 85 °C (option)	-8

Options:² (Surface mount version - NFND) M¹²

(C-pinout - NFND) C¹²

Open frame Z

20 IMX 7 - 05 - 05 - 9 M C Z .

¹ Option M and Z excludes option C and vice versa.

² For delivery lead times contact factory. Some types are not recommended for new designs (NFND = not for new designs).

Examples: 40 IMX 7-05-05-9Z: DC-DC converter, input voltage range 16.8 - 75 V, 2 electrically isolated outputs each providing 5 V, 700 mA with no cover.

Functional Description

The IMX 7 DC-DC modules are feedback controlled flyback converters using current mode PWM (Pulse Width Modulation). See block diagram for single and double output types.

In the case of the single output units the output is directly monitored and fed back to the primary control circuit via a pulse transformer, resulting in tight regulation of the output voltage. The R input is referenced to the secondary side and allows for programming of the output voltages in the range 75 to 105% of $V_{o\ nom}$ using either an external resistor or an external voltage source.

In the case of the dual and double output units the output voltage is monitored by a separate transformer winding close to the secondary windings and fed back to the control circuit. The R (Trim) input is referenced to the primary side and allows programming of the output voltage in the range 100 to 105% of $V_{o\ nom}$ by an external resistor or within 75 to 105% of $V_{o\ nom}$ using an external voltage source.

Current limitation is provided by the primary circuit, thus limiting the total output power.

The inhibit input allows remote converter on/off.

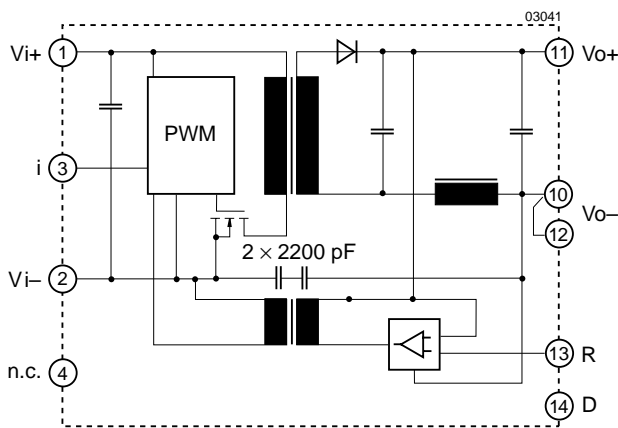

Fig. 1
Block diagram, single output types, standard pinout

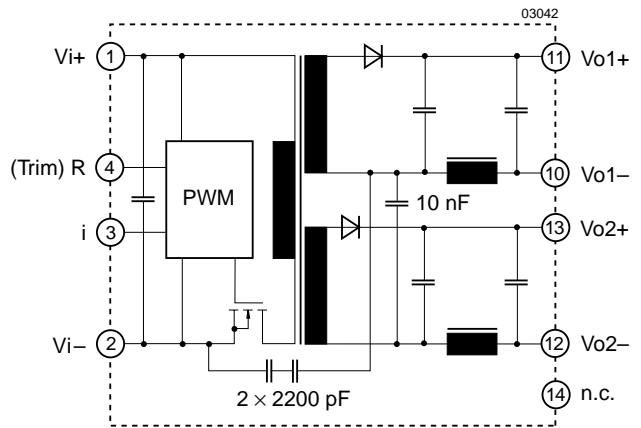

Fig. 2
Block diagram, double output types, standard pinout

Electrical Input Data

General conditions:

- $T_A = 25^\circ\text{C}$, unless T_C is specified.
- Connector pins i and Vi– interconnected.
- Trim or R input not connected.

Table 2: Input Data

Input			20 IMX 7		40 IMX 7		70 IMX 7		110 IMX 7		Unit	
Characteristics		Conditions	min	typ	max	min	typ	max	min	typ	max	
V_i	Input voltage range ¹	$T_C \text{ min...} T_C \text{ max}$	8.4		36	16.8 ⁶		75	40		121	V DC
$V_{i \text{ nom}}$	Nominal input voltage	$I_o = 0...I_o \text{ nom}$	20		40		70		110			
$V_{i \text{ sur}}$	Repetitive surge voltage	abs. max input (3 s)	50 ⁵		4		4		4			
$t_{\text{start up}}$	Converter ² start-up time	switch on	0.25		0.5		0.25		0.5		s	
		inh. release	0.1		0.1		0.1		0.1			
t_{rise}	Rise time ²	$V_{i \text{ nom}}$ resistive load	5		5		5		5		ms	
		$I_o \text{ nom}$ capacitive load	12		12		12		12			
$I_{i \text{ o}}$	No load input current	$I_o = 0, V_{i \text{ min...}} V_{i \text{ max}}$	15 30		8 15		8 15		8 15		mA	
C_i	Input capacitance	for surge calculation	4.7		0.5		0.2		0.2		μF	
V_{inh}	Inhibit voltage	unit operating	–10...0.8		–10 ...0.8		–10 ...0.8		–10 ...0.8		V DC	
		unit inhibited	open or 2.4... $V_{i \text{ max}}$		open or 2.4... $V_{i \text{ max}}$		open or 2.4...75		open or 2.4...75			
I_{inh}	Inhibit current	unit operating	–0.5		–0.5		–0.5		–0.5		mA	
		unit inhibited	1		1		1		1			
$I_{i \text{ inh}}$	Input current if unit shut down	$V_{i \text{ min...}} V_{i \text{ max}}$	<3.0		<3.0		<3.0		<3.0			
$I_{\text{inr p}}$	Inrush peak current	$V_i = V_{i \text{ nom}}$ ⁷	3.8		3.7		4.2		5.6		A	
f_s	Switching frequency	$V_{i \text{ min...}} V_{i \text{ max}}, I_o = 0...I_o \text{ nom}$	approx. 400		approx. 400		approx. 400		approx. 300		kHz	
$I_{i \text{ rr}}$	Reflected ripple current	$I_o = 0...I_o \text{ nom}$	50		30		20		10		mA_{pp}	
$V_{i \text{ RFI}}$	Input RFI level conducted and radiated	EN 55022 ³	B		B		B		B			

¹ $V_{i \text{ min}}$ will not be as stated if V_o is increased above $V_{o \text{ nom}}$ by use of the R input. If the output voltage is set to a higher value, $V_{i \text{ min}}$ will be proportionally increased.

² Measured with a resistive and max. admissible capacitive load.

³ Measured with a lead length of 0.1 m, leads twisted. Double output units with both outputs in parallel. 70/110 IMX 7 types need an external capacitor at the input. (e.g. $1\mu\text{F}$ film or ceramic)

⁴ See 19 Pfl 1: *Electromagnetic Immunity*.

⁵ The DC-DC converter shuts down automatically at approx. 38 V.

⁶ Operation at lower input voltage possible: P_o approx. 80% of $P_{o \text{ nom}}$ at $V_{i \text{ min}} = 14.4$ V.

⁷ Source impedance according to prETS 300132-2, version 4.3, at $V_{i \text{ nom}}$.

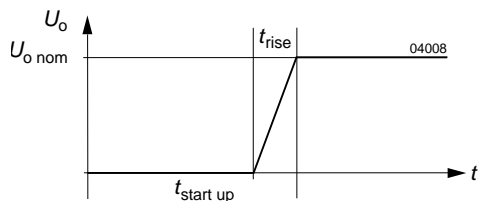

Fig. 3
Converter start-up and rise time

Input Transient Voltage Protection

In many applications transient voltages on the input of the converter are always possible. These may be caused for example by short circuits between Vi+ and Vi- where the network inductance may cause high energy pulses.

In order to protect the converters the IMX 7 types have a built-in transient protection as per table below:

Table 3: Built-in transient voltage suppressor

Type	Breakdown Voltage $V_{BR\ nom}$	Peak Power at 1 ms P_P	Peak Pulse Current I_{PP}
20 IMX 7 ¹	over voltage lockout at approx. 38 V		
40 IMX 7 ²	100 V	1500 W	11 A
70 IMX 7 ²	144 V	600 W	2.9 A
110 IMX 7 ²	167 V	600 W	2.5 A

¹ The built-in overvoltage lockout circuit shuts down the converter at approx. 38 V protecting the input up to 50 V DC. For higher transient voltages an external suppressor or voltage limiting circuit as e.g. for IEC/EN 61000-4-5, level 2 compliance should be provided.

² If transients generating currents above the peak pulse current are possible then an external limiting network such as the circuit recommended for IEC/EN 61000-4-5, level 2 compliance is necessary.

Table 4: Components for external circuitry to comply with IEC/EN 61000-4-5

Circuit Ref.	20 IMX 7	40 IMX 7	70 IMX 7	110 IMX 7
L	330 μ H, 0,115 Ω , 1 A TDK SF-T8-110S-01	330 μ H, 0,42 Ω , 600 mA TDK TSL1110-331KR55	1000 μ H, 2.9 Ω , 290 mA Toko 822LY-102K	330 μ H, 0.65 Ω , 430 mA Toko 822LY-331K
C	68 μ F, 63 V, 85°C	68 μ F, 100 V, 85°C	47 μ F, 150 V, 85°C	200 μ F, 200 V, 105°C
D	Motorola 1.5KE39A	n.a.	n.a.	n.a.

Reverse Polarity Protection at Input

The suppressor diode on the input also provides for reverse polarity protection by conducting current in the reverse direction, thus protecting the unit. An external fuse is required to limit this current:

- For 20 IMX 7 a fast 2 A (F2A) fuse is recommended.
- For 40 IMX 7 a fast 1 A (F1A) fuse is recommended.
- For 70 IMX 7 a fast 0.63 A (F.63A) fuse is recommended.
- For 110 IMX 7 a fast 0.63 A (F.63A) fuse is recommended.

Inrush Current

The inrush current has been kept as low as possible by choosing a very small input capacitance. A series resistor may be inserted in the input line to limit this current further.

To achieve IEC/EN 61000-4-5, level 2 compliance an additional inductor and capacitor should be provided externally as shown in the figure below. The components should have similar characteristics as listed in table: *Components for external circuitry to comply with IEC/EN 61000-4-5.*

Please note: The suppressor diode D is only necessary for 20 IMX 7 types. To withstand 150 V transients according to 19 Pfl 1, applicable for 40 IMX 7 types, the same external circuitry with similar components as for IEC/EN 61000-4-5, level 2 compliance can be used.

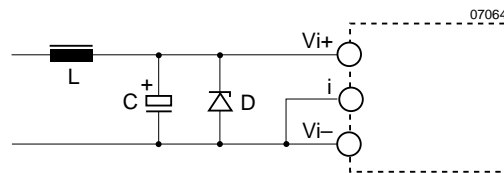

Fig. 4
Example for external circuitry to comply with IEC/EN 61000-4-5, level 2 (transzorb D not necessary for 40/70/110 IMX 7 types).

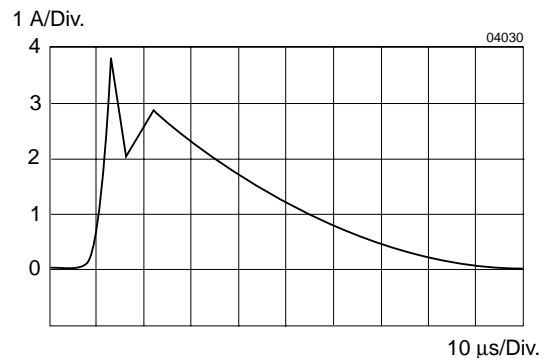

Fig. 5
Typical inrush current at $V_{i\ nom}$, $P_{o\ nom}$ vs. time (40 IMX 7) measured according to prETS 300132-2 (Version 4.3)

Electrical Output Data

General conditions:

- $T_A = 25^\circ\text{C}$, unless T_C is specified.
- Connector pins i and Vi– interconnected.
- Trim or R input not connected.

Table 5a: Output data for single output units

Output		$V_{o\text{ nom}}$	3.3 V		5.1 V		Unit	
Characteristics		Conditions	min	typ	max	min		typ
V_{o1}	Output voltage	$V_{i\text{ nom}}$	3.28	3.32	5.07	5.13	VDC	
$I_{o\text{ nom}}$	Output current	$V_{i\text{ min}} \dots V_{i\text{ max}}$	1.5		1.2		A	
I_{oL}	Current limit ²	$V_{i\text{ nom}}, T_C = 25^\circ\text{C}$	3.0		2.4			
ΔV_o	Line and load regulation	$V_{i\text{ min}} \dots V_{i\text{ max}}$ $I_o = (0.05 \dots 1) I_{o\text{ nom}}$	± 1		± 1		%	
$V_{o1,2}$	Output voltage noise 20/40/70 IMX 110 IMX	$V_{i\text{ min}} \dots V_{i\text{ max}}$ $I_o = I_{o\text{ nom}}$	⁵	70	70		mV _{pp}	
			⁶	20	40	20		40
				40	50	40		50
$V_{o\text{ clp}}$	Output overvoltage limitation ⁷		115	130	115	130	%	
$C_{o\text{ ext}}$	Admissible capacitive load		≤ 2500		≤ 2000		μF	
$V_{o\text{ d}}$	Dynamic load regulat.	Voltage deviat.	± 250		± 250		mV	
t_d		Recovery time	1		1		ms	
α_{V_o}	Temperature coefficient $\Delta V_o / \Delta T_C (T_{C\text{ min}} \dots T_{C\text{ max}})$	$V_{i\text{ min}} \dots V_{i\text{ max}}$ $I_o = 0 \dots I_{o\text{ max}}$	± 0.02		± 0.02		%/K	

Table 5b: Output data for single output units

Output		$V_{o\text{ nom}}$	12 V		15 V		24 V		Unit
Characteristics		Conditions	min	typ	max	min	typ	max	
V_{o1}	Output voltage	$V_{i\text{ nom}}$	11.90	12.10	14.88	15.12	23.81	24.19	VDC
$I_{o\text{ nom}}$	Output current ¹	$V_{i\text{ min}} \dots V_{i\text{ max}}$	20 IMX		0.5		0.26		A
			40/70/110 IMX		0.6		0.3		
I_{oL}	Current limit ^{2, 3}	$V_{i\text{ nom}}, T_C = 25^\circ\text{C}$	20 IMX		1.0		0.95		%
			40/70/110 IMX		1.2		1.1		
ΔV_o	Line regulation	$V_{i\text{ min}} \dots V_{i\text{ max}}, I_{o\text{ nom}}$	± 1		± 1		± 1		
ΔV_{o1}	Load regulation ⁴	$V_{i\text{ nom}}$ $I_o = (0.1 \dots 1) I_{o\text{ nom}}$	± 3		± 3		± 3		
$V_{o1,2}$	Output voltage noise	$V_{i\text{ min}} \dots V_{i\text{ max}}$ $I_o = I_{o\text{ nom}}$	⁵	120	150	240		mV _{pp}	
			⁶	25	50	30	60		50
$V_{o\text{ clp}}$	Output overvoltage limit. ⁷	Minimum load 1%	115	130	115	130	115	130	%
$C_{o\text{ ext}}$	Admissible capacitive load ³		≤ 300		≤ 200		≤ 100		μF
$V_{o\text{ d}}$	Dynamic load regulat.	Voltage deviat.	± 330		± 350		± 600		mV
t_d		Recovery time	1		1		1		ms
α_{V_o}	Temperature coefficient $\Delta V_o / \Delta T_C (T_{C\text{ min}} \dots T_{C\text{ max}})$	$V_{i\text{ min}} \dots V_{i\text{ max}}$ $I_o = 0 \dots I_{o\text{ max}}$	± 0.02		± 0.02		± 0.02		%/K

¹ Each output is capable of delivering full output power, $P_{o\text{ nom}}$ according to table: Model Selection.

² The current limit is primary side controlled.

³ Measured with both side outputs connected in parallel.

⁴ Conditions for specified output. Other output loaded with constant current $I_o = 0.5 I_{o\text{ nom}}$.

⁵ BW = 20 MHz

⁶ Measured with a probe according to EN 61204.

⁷ The overvoltage protection is not tracking with the R control.

Table 5c: Output data for double output units

Output		$V_{o\ nom}$	2 X 5 V			2 X 12 V			2 X 15 V			2 X 24 V			Unit
Characteristics	Conditions		min	typ	max	min	typ	max	min	typ	max	min	typ	max	
V_{o1} V_{o2}	Output voltage	$V_{i\ nom}$ $I_o = 0.5 I_{o\ nom}$	4.96	5.04		11.90	12.10		14.88	15.12		23.81	24.19		VDC
			4.95	5.05		11.88	12.12		14.85	15.15		23.75	24.25		
$I_{o\ nom}$	Output current ¹	$V_{i\ min...} V_{i\ max}$	2 ∞ 0.6			2 ∞ 0.25			2 ∞ 0.2			2 ∞ 0.13			A
	20 IMX 40/70/110 IMX		2 ∞ 0.7			2 ∞ 0.3			2 ∞ 0.24			2 ∞ 0.15			
I_{oL}	Current limit 2, 3	$V_{i\ nom}, T_C = 25^\circ C$	2.4			1.0			0.95			0.5			
	20 IMX 40/70/110 IMX		2.8			1.2			1.1			0.6			
ΔV_o	Line regulation	$V_{i\ min...} V_{i\ max}, I_{o\ nom}$	±1			±1			±1			±1			%
ΔV_{oI}	Load regulation ⁴	$V_{i\ nom}$ $I_o = (0.1...1) I_{o\ nom}$	±3			±3			±3			±3			
$V_{o1,2}$	Output voltage noise	$V_{i\ min...} V_{i\ max}$ $I_o = I_{o\ nom}$	80			120			150			240			mV _{pp}
			20	40		25	50		30	60		50	100		
$V_{o\ clp}$	Output overvoltage limit. ⁷	Minimum load 1%	115	130		115	130		115	130		115	130		%
$C_{o\ ext}$	Admissible capacitive load ³		≤2000			≤300			≤200			-100			μF
$V_{o\ d}$	Dynamic load regulat.	Voltage deviat.	±150			±330			±350			±600			mV
t_d	Recovery time	$I_{o\ nom} \times 1/2 I_{o\ nom}$	1			1			1			1			ms
α_{V_o}	Temperature coefficient	$V_{i\ min...} V_{i\ max}$ $I_o = 0...I_{o\ max}$	±0.02			±0.02			±0.02			±0.02			%/K
	$\Delta V_o / \Delta T_C (T_{C\ min...} T_{C\ max})$		±0.02			±0.02			±0.02			±0.02			

¹ Each output is capable of delivering full output power, $P_{o\ nom}$ according to table: *Model Selection*.

² The current limit is primary side controlled.

³ Measured with both outputs connected in parallel.

⁴ Conditions for specified output. Other output loaded with constant current $I_o = 0.5 I_{o\ nom}$.

⁵ BW = 20 MHz

⁶ Measured with a probe according to EN 61204.

⁷ The overvoltage protection is not tracking with the R control.

Short Circuit Behaviour

The current limit characteristic shuts down the converter whenever a short circuit is applied to its output. It acts self-protecting and automatically recovers after removal of the overload condition (hiccup mode).

Thermal Considerations

If a converter, mounted on a pcb, is located in free, quasi-stationary air (convection cooling) at the indicated maximum ambient temperature $T_{A \max}$ (see table: *Temperature specifications*) and is operated at its nominal input voltage and output power, the case temperature T_C measured at the *Measuring point of case temperature T_C* (see: *Mechanical Data*) will approach the indicated value $T_{C \max}$ after the warm-up phase. However, the relationship between T_A and T_C depends heavily on the conditions of operation and integration into a system. The thermal conditions are influenced by input voltage, output current, airflow, temperature of surrounding components and surfaces and the properties of the printed circuit board. $T_{A \max}$ is therefore only an indicative value and under practical operating conditions, the ambient temperature T_A may be higher or lower than this value.

Caution: The case temperature T_C measured at the *Measuring point of case temperature T_C* (see: *Mechanical Data*) may under no circumstances exceed the specified maximum value. The installer must ensure that under all operating conditions T_C remains within the limits stated in the table: *Temperature specifications*.

Typical Performance Curves

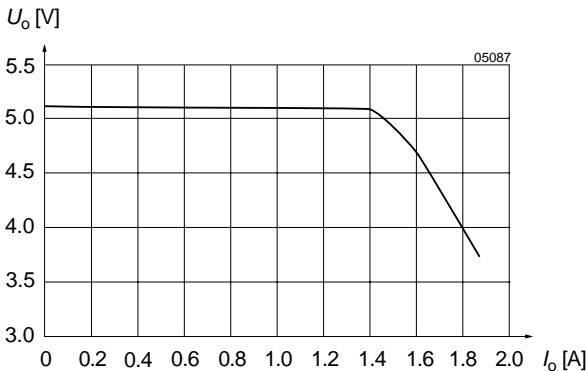

Fig. 6 V_o versus I_o (typ) of single output units with $V_o = 5.1$ V.

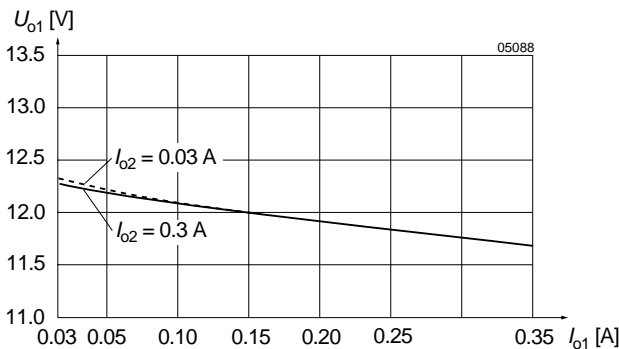

Fig. 8 v_{o1} versus I_{o1} (typ) for various I_{o2} (2 x 12 V). The cross load effect is negligible.

Connection in Series or in Parallel

Connection in series:

The outputs of single or double output units can be connected in series without any precautions, taking into consideration that the highest output voltage should remain below 60 V for SELV operation.

Connection in parallel:

Double outputs of the same converter with equal output voltage (e.g. 5V / 5V) can be put in parallel and will share their output currents almost equally. Parallel operation of single or double outputs of two or more converters with the same output voltage may cause start-up problems at initial start-up. This is only advisable in applications where one converter is able to deliver the full load current as required in true redundant systems.

Output overvoltage protection

The outputs of single output units and -05-05- types are protected against overvoltages by a second control loop. In the event of an overvoltage on the output the unit will shut-down and attempt to restart approximately every 0.4 seconds. Double output units (with exception of the -05-05-types) are protected against overvoltages by a Zener diode across the second output. Under worst case conditions the Zener diode will short circuit. Since with double output units both outputs track each other the protection diode is only provided in one of the outputs. The main purpose of this feature is to protect against possible overvoltages which could occur due to a failure in the feedback control circuit. The output overvoltage protection is not designed to withstand externally applied overvoltages.

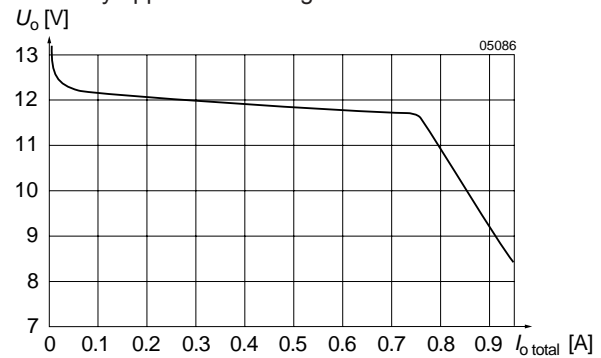

Fig. 7 V_o versus I_o (typ) of double output units, with both outputs in parallel.

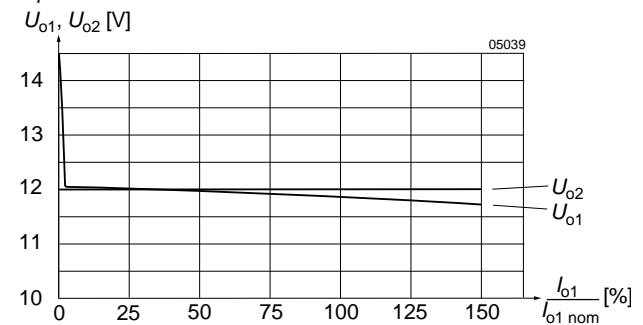

Fig. 9 Flexible load distribution on double outputs (2 x 12 V) with load variation from 0...150% of $P_{o1 \text{ nom}}$ on output 1. Output 2 loaded with 25% of $P_{o2 \text{ nom}}$.

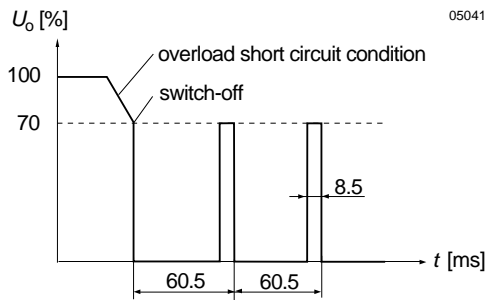

Fig. 10
Overload switch-off (hiccup mode). Typical values.
Frequency of pulses: 16.5 Hz, puls duration: 8.5 ms.

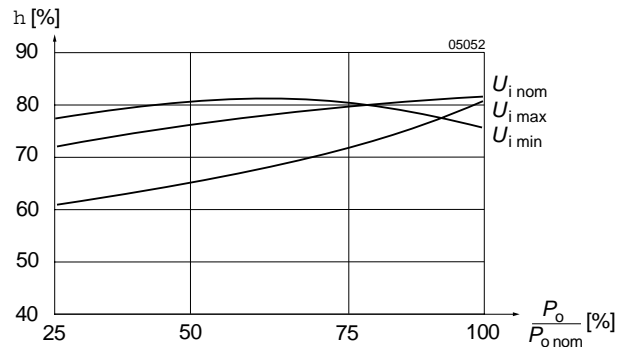

Fig. 11
Efficiency versus input voltage and load. Typical values
(40 IMX 7-12-12).

Auxiliary Functions

Inhibit Function

The output(s) of the converter may be enabled or disabled by means of a logic signal (TTL, CMOS, etc.) applied to the inhibit pin. No output voltage overshoot will occur when the unit is turned on. If the inhibit function is not required the inhibit pin should be connected to Vi- to enable the output (active low logic, fail safe).

Converter operating: -10 V...0.8 V
Converter inhibited
or inhibit pin left open: 2.4 V...Vi max
(<75 V for 70/110 IMX 7)

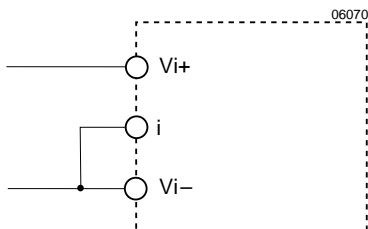

Fig. 12
If the inhibit is not used the inhibit pin should be connected to Vi-

Adjustable Output Voltage (R input)

As a standard feature, the IMX 7 single and double output units offer adjustable output voltage(s) by using the control input R. If the R pin is left open circuit the output voltage is set to $V_{o\ nom}$. The output voltage is adjustable in the range 75...105% of $V_{o\ nom}$. The circuit works for single and double output units in a different way. For output voltages $V_o > V_{o\ nom}$, the minimum input voltage $V_{i\ min}$ (see: *Electrical Input Data*) increases proportionally to $V_o/V_{o\ nom}$.

Single output units:

The R input is referenced to the secondary side of the converter. Adjustment of the output voltage is possible by means of either an external resistor or a voltage source.

a) Adjustment by means of an external resistor R_{ext1} :

Depending upon the value of the required output voltage, the resistor shall be connected

either: Between the R pin and Vo- to achieve an output voltage adjustment range of approximately $V_o = 75...100\% V_{o\ nom}$. (85...100% for 3.3 V outputs)

$$R_{ext1} = 4\text{ k}\Omega \cdot \frac{V_o}{V_{o\ nom} - V_o}$$

or: Between the R pin and Vo+ to achieve an output voltage range of approximately $V_o = 100...105\% V_{o\ nom}$.

$$R_{ext2} = 4\text{ k}\Omega \cdot \frac{(V_o - 2.5\text{ V})}{2.5\text{ V} \cdot (V_o/V_{o\ nom} - 1)}$$

b) Adjustment by means of an external voltage V_{ext} between V_{o-} and R pins.

The control voltage range is 1.87...2.62 V and allows for an adjustment in the range of approximately 75...105% (85...105% for 3.3 V outputs)

$$V_{ext} = \frac{V_o \cdot 2.5 V}{V_{o\ nom}}$$

Attempting to adjust the output below this range will cause the converter to shutdown (hiccup mode).

Note: Applying an external control voltage >2.75 V may damage the converter.

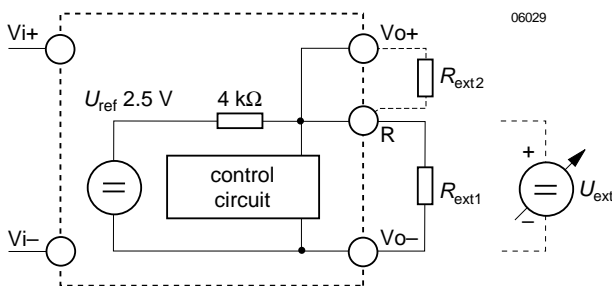

Fig. 13
Output voltage control for single output units by means of the R-input

Double output units:

The R input (Trim) input is referenced to the primary side. The figure below shows the circuit topology. Adjustment of the output voltage is possible by means of either an external resistor in the range of 100...105% of $V_{o\ nom}$, or an external voltage source in the range of 75...105% of $V_{o\ nom}$.

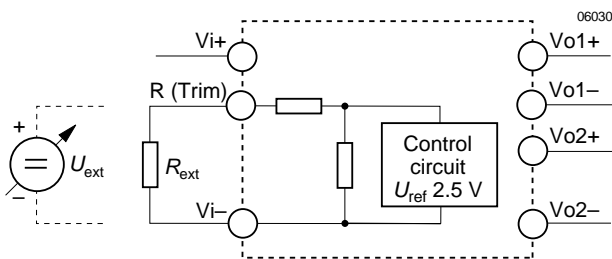

Fig. 14
Output voltage control for double output units by means of the R input

a) Adjustment by means of an external resistor.

Programming of the output voltage by means of an external resistor R_{ext1} is possible within a limited range of 100...105% of $V_{o\ nom}$. R_{ext1} should be connected between the R-pin and V_{i-} . Connection of R_{ext1} to V_{i+} may damage the converter. The following table indicates suitable resistor values for typical output voltages under nominal conditions ($V_{i\ nom}$, $I_o = 0.5 I_{o1/2\ nom}$), with either paralleled outputs or equal load conditions on each output.

Table 6: R_{ext1} for $V_o > V_{o\ nom}$;
approximate values ($V_{i\ nom}$, $I_{o1,2} = 0.5 I_{o1/2\ nom}$)

V_o [% $V_{o\ nom}$]	R_{ext} [kΩ]
105...108 (107 typically)	0
105	1.5
104	5.6
103	12
102	27
101	68
100	∞

b) Adjustment by means of an external voltage source V_{ext} .

For external output voltage programming in the range 75...105% of $V_{o\ nom}$ a (0...20 V) source V_{ext} is required, connected to the R-pin and V_{i-} . The table below indicates typical V_o versus V_{ext} values under nominal conditions ($V_{i\ nom}$, $I_o = 0.5 I_{o\ nom}$), with either paralleled outputs or equal load conditions on each output. Applying a control voltage greater than 20 V will set the converter into a hiccup mode. Direct paralleling of the R-pins of units connected in parallel is feasible.

Table 7: V_{ext} for $U_o = 75...105\% V_{o\ nom}$;
typical values ($V_{i\ nom}$, $I_{o1,2} = 0.5 I_{o1/2\ nom}$)

V_o [% $U_{o\ nom}$]	V_{ext} [V]
•105	0
102	1.6
95	4.5
85	9
75	13

Electromagnetic Compatibility (EMC)

A suppressor diode together with an input filter form an effective protection against high input transient voltages

which typically occur in many installations, but especially in battery driven mobile applications.

Electromagnetic Immunity

Table 8: Immunity type tests

Phenomenon	Standard ¹	Class Level	Coupling mode ²	Value applied	Waveform	Source Imped.	Test procedure	In oper.	Per. ³ form.
Electrostatic discharge to case	IEC/EN 61000-4-2	2	contact discharge R pin open i pin connec. to Vi-	4000 V _p	1/50 ns	330 Ω	10 positive and 10 negative discharges	yes	B
		3	air discharge R pin open i pin connec. to Vi-	8000 V _p					
Electromagnetic field	IEC/EN 61000-4-3	3	antenna	10 V/m	AM 80% 1 kHz		26...1000 MHz	yes	A
	ENV 50204				PM, 50% duty cycle, 200 Hz resp. frequ.		900 MHz		
Electrical fast transient/burst	IEC/EN 61000-4-4	4	direct +i/-i	4000 V _p	bursts of 5/50 ns 5 kHz rep. rate transients with 15 ms burst duration and a 300 ms period	50 Ω	1 min positive 1 min negative transients per coupling mode	yes	B
Surge	IEC/EN 61000-4-5 ⁵	3	+i/-i	2000 V _p	1.2/50 μs	2 Ω	5 pos. and 5 neg. impulses per coupling mode	yes	B
Conducted disturbances	IEC/EN 61000-4-6	3	+i/-i	10 V _{rms} (140 dBμV)	AM modulated 80%, 1 kHz	50 Ω	0.15...80 MHz 150 Ω	yes	A
Transient	19 Pfl 1 ⁴		+i/-i	150 V _p	0.1/0.3 ms	limited to <100 A	3 positive	yes	B

¹ Related and previous standards are referenced in: *Technical Information: Standards.*

² i = input, o = output.

³ A = normal operation, no deviation from specification, B = temporary deviation from specs. possible.

⁴ For 40 IMX 7 types (additional external components required). Not applicable for 20 IMX 7 types.

⁵ External components required.

Electromagnetic Emission

Conducted RFI noise at input according to EN 55022

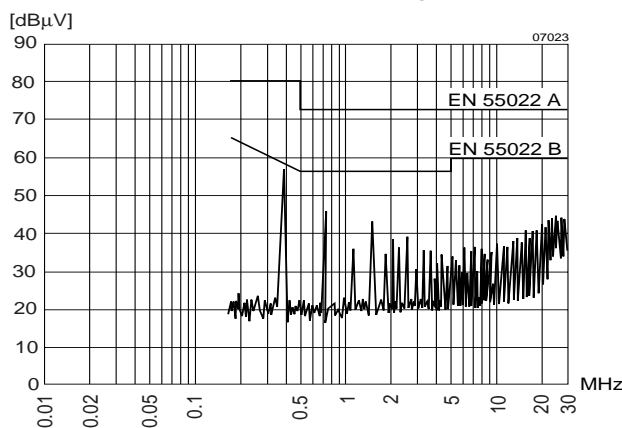

Fig. 15
Typical disturbance voltage (quasi-peak) at the input according to CISPR 11/EN 55011 and CISPR 22/EN 55022 measured at $U_{i,nom}$ and $I_{o,nom}$. Output leads 0.1 m, twisted. (40 IMX 7-15-15). External capacitor (1 μF ceramic or film) required at the input for 70 IMX 7, 110 IMX 7 types.

Radiated RFI noise according to EN 55022.

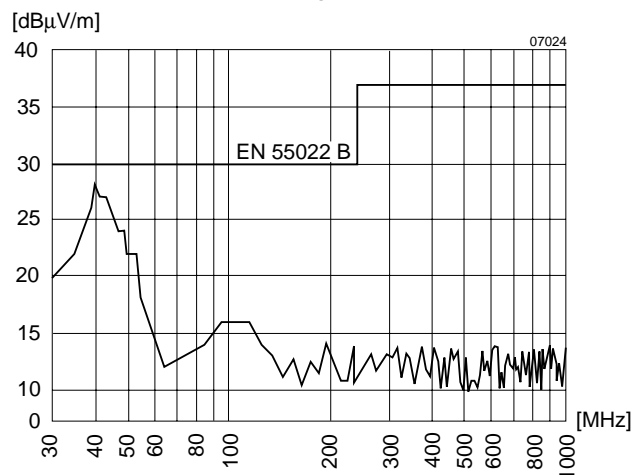

Fig. 16
Typical radio frequency-interference voltage at $V_{i,nom}$, $I_{o,nom}$, measured with an antenna (distance 10 m). Output leads 0.1 m, twisted (70 IMX-7-15-15).

Immunity to Environmental Conditions

Table 9: Environmental testing

Test Method		Standard	Test Conditions		Status
Ca	Damp heat steady state	IEC/DIN IEC 60068-2-3 MIL-STD-810D section 507.2	Temperature: Relative humidity: Duration:	40 ±2 °C 93 +2/-3 % 56 days	Unit not operating
Ea	Shock (half-sinusoidal)	IEC/EN/DIN EN 60068-2-27 MIL-STD-810D section 516.3	Acceleration amplitude: Bump duration: Number of bumps:	100 g _n = 981 m/s ² 6 ms 18 (3 each direction)	Unit operating
Eb	Bump (half-sinusoidal)	IEC/EN/DIN EN 60068-2-29 MIL-STD-810D section 516.3	Acceleration amplitude: Bump duration: Number of bumps:	40 g _n = 392 m/s ² 6 ms 6000 (1000 each direction)	Unit operating
Fc	Vibration (sinusoidal)	IEC/EN/DIN EN 60068-2-6	Acceleration amplitude: Frequency (1 Oct/min): Test duration:	0.35 mm (10...60 Hz) 5 g _n = 49 m/s ² (60...2000 Hz) 10...2000 Hz 7.5 h (2.5 h each axis)	Unit operating
Fh	Vibration, broad-band random (digital control)	IEC/EN 60068-2-64 MIL-STD-810D section 514.3	Acceleration spectral density: Frequency band: Acceleration magnitude: Test duration:	0.05 g _n ² /Hz 20...500 Hz 4.9 g _{n rms} 3 h (1 h each axis)	Unit operating
Kb	Salt mist, cyclic (sodium chloride NaCl solution)	IEC/EN/DIN IEC 60068-2-52	Concentration: Duration: Storage: Storage duration: Number of cycles:	5% (30 °C) 2 h per cycle 40 °C, 93% rel. humidity 22 h per cycle 3	Unit not operating

Table 10: Temperature specifications, valid for air pressure of 800...1200 hPa (800...1200 mbar)

Temperature		Standard -9		Option -8		Unit
Characteristics	Conditions	min	max	min	max	
T _A Ambient temperature ¹	Operational ²	-40	71	-40	85	°C
T _C Case temperature		-40	95	-40	105	
T _S Storage temperature ¹	Non operational	-40	100	-55	105	

¹ MIL-STD-810D section 501.2 and 502.2

² See: *Thermal Considerations*

Table 11: MTBF and device hours

MTBF	Ground Benign	Ground Fixed		Ground Mobile
MTBF acc. to MIL-HDBK-217F	T _C = 40 °C	T _C = 40 °C	T _C = 70 °C	T _C = 50 °C
40 IMX 7-05-9	1,671,700 h	248,000 h	83,800 h	84,800 h
40 IMX 7-15-15-9	1,640,000 h	214,000 h	83,000 h	77,000 h

Safety and Installation Instructions

Installation Instruction

Installation of the DC-DC converters must strictly follow the national safety regulations in compliance with the enclosure, mounting, creepage, clearance, casualty, markings and segregation requirements of the end-use application.

Connection to the system shall be made via a printed circuit board according to: *Mechanical Data*.

The units should be connected to a secondary circuit.

Check for hazardous voltages before altering any connections.

Do not open the module.

Ensure that a unit failure (e.g. by an internal short-circuit) does not result in a hazardous condition. See also: *Safety of operator accessible output circuit*.

Input Fuse

To prevent excessive current flowing through the input supply line in case of a short-circuit across the converter input an external fuse should be installed in a non earthed input supply line. We recommend a fast acting fuse F2A for 20 IMX 7 and F1A for 40 IMX 7 and F0.63A for 70/110 IMX 7 types.

Cleaning Agents

In order to avoid possible damage, any penetration of cleaning fluids has to be prevented, since the power supplies are not hermetically sealed.

Standards and approvals

All DC-DC converters are pending to be UL recognized according to UL 1950, UL recognized for Canada to CAN/CSA C22.2 No. 950-95 and LGA approved to IEC/EN 60950 standards.

The units have been evaluated for:

- Building in
- Supplementary insulation input to output, based on their maximum input voltage
- The use in a pollution degree 2 environment
- Connecting the input to a secondary circuit which is subject to a maximum transient rating of 1500 V for 20/40 IMX 7, 2000 V for 70 IMX 7 and 2500 V for 110 IMX 7 types.

The DC-DC converters are subject to manufacturing surveillance in accordance with the above mentioned UL, CSA, EN and ISO 9001 standards.

Protection Degree

The protection degree of the DC-DC converters is IP 30.

Isolation

The electric strength test is performed as factory test in accordance with IEC/EN 60950 and UL 1950 and should not be repeated in the field. Power-One will not honour any guarantee claims resulting from electric strength field tests.

Table 12: Electric strength test voltages

Characteristic	I/O			O/O	Unit
	20/40 IMX	70 IMX	110 IMX		
Electric strength test voltage 1 s	1.2	1.5	2.0	0.1	kV _{rms}
	1.5	2.0	2.5	0.15	kV DC
Coupling capacitance	1.2	1.2	1.2	-	nF
Insulation resist. at 500 V DC	>100	>100	>100	-	MΩ
Partial discharge extinction voltage	Consult factory			-	kV

Table 13: Pin allocation, standard pinout

Pin	Single output	Double output
1	Vi+	Vi+
2	Vi-	Vi-
3	i	i
4	n.c.	R (Trim)
10	Vo-	Vo1-
11	Vo+	Vo1+
12	Vo-	Vo2-
13	R	Vo2+
14	n.c.	n.c.

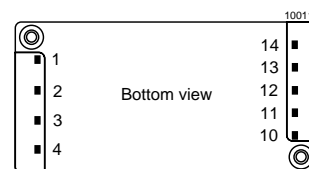

Fig. 19
Pin allocation standard pinout

Safety of operator accessible output circuit

If the output circuit of a DC-DC converter is operator accessible, it shall be an SELV circuit according to IEC/EN 60950 related safety standards.

The insulation concept table below shows some possible installation configurations, compliance with which causes the output circuit of the DC-DC converter to be an SELV circuit according to IEC/EN 60950 up to a configured output voltage (sum of nominal voltages if in series or +/- configuration) of 46 V.

However, it is the sole responsibility of the installer to ensure the compliance with the relevant and applicable safety regulations. More information is given in: *Technical Information: Safety*.

Table 16: Insulation concept leading to an SELV output circuit

Conditions	Front end			DC-DC converter	Result
Supply voltage	Minimum required grade of isolation, to be provided by the AC-DC front end, including mains supplied battery charger	Maximum DC output voltage from the front end ¹	Minimum required safety status of the front end output circuit	Measures to achieve the specified safety status of the output circuit	Safety status of the DC-DC converter output circuit
Mains -250 V AC	Basic	<60 V	Earthed SELV circuit ²	Operational insulation (provided by the DC-DC converter)	SELV circuit
			ELV circuit	Input fuse ³ output suppressor diode(s) ⁴ , and earthed output circuit(s) ²	Earthed SELV circuit
		>60 V	Hazardous voltage secondary circuit		
	Double or reinforced	<60 V	SELV circuit	Operational insulation (provided by the DC-DC converter)	SELV circuit
			TNV-2 circuit	Supplementary insulation, based on the maximum input voltage (provided by the DC-DC converter)	
		>60 V	Double or reinforced insulated unearthed hazardous voltage secondary circuit ⁵		

¹ The front end output voltage should match the specified input voltage range of the DC-DC converter.

² The earth connection has to be provided by the installer according to the relevant safety standard, e.g. IEC/EN 60950.

³ The installer shall provide an approved fuse (type with the lowest rating suitable for the application) in a non-earthed input line directly at the input of the DC-DC converter (see fig.: *Schematic safety concept*). For UL's purpose, the fuse needs to be UL-listed. See also: *Input Fuse*.

⁴ Each suppressor diode should be dimensioned in such a way, that in the case of an insulation fault the diode is able to limit the output voltage to SELV (<60 V) until the input fuse blows (see fig.: *Schematic safety concept*).

⁵ Has to be insulated from earth by basic insulation according to the relevant safety standard, based on the maximum output voltage from the front end.

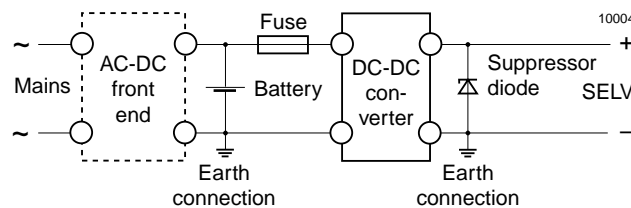

Fig. 20

Schematic safety concept. Use fuse, suppressor diode and earth connection as per table: Safety concept leading to an SELV output circuit.

Description of Options

Table 17: Survey of options

Option	Function	Characteristics
-8	Operational temperature range $T_A = -40$ to 85°C	Extended temperature range.
Z	Open Frame	

Option -8

Extension of the temperature range from standard -25 to 71°C to -40 to 85°C .

The module will provide full output power with free air convection cooling.

UL recognition up to 80°C .