

Wide input voltage ranges up to 150 VDC
1500 VDC I/O electric strength test voltage

Features

- Extremely wide input voltage ranges
- Electrical isolation I/O, also between outputs
- Emissions below EN 55022, level B
- Immunity to IEC/EN 61000-4-2,-3,-4,-5 and -6
- Programmable input undervoltage lockout
- Shut down/inhibit input
- Output voltages adjustable with flexible load distribution
- Frequency synchronization
- Outputs no-load, overload, and short-circuit proof
- Operating ambient temperature from -40 to 110°C
- Thermal protection
- 3" x 2.5" case with 10.5 mm profile or 8.9 mm open frame
- Basic insulation
- Flexible output possibilities between 3.3 V & 60 V

Safety according to IEC/EN 60950, UL 1950



Description

The IMX35 Series of board-mountable, 35 Watt dc-dc converters has been designed according to industry requirements and standards. The converters are particularly suitable for use in mobile or stationary applications in transport, railways, industry, or telecommunication where variable input voltages or high transient voltages are prevalent.

Covering a total input voltage range from 9V up to 150V with four different types. The units are available with up to quadruple outputs (electrically isolated) from 3.3 V up to 60V externally adjustable and with flexible load distribution. A shut down input allows remote converter on/off. Features include consistently high efficiency over the entire input voltage range, high reliability, and excellent dynamic response to load and line changes.

The converters are designed and built according to the international safety standards IEC/EN 60950, UL 1950, CAN/ CSA C22.2 No.950-95. They are also

LGA, UL and cUL approved. The IMX35 types provide basic insulation.

The circuit is comprised of two planar magnetics devices and all components are automatically assembled and solidly soldered onto a single PCB without any wire connection. Magnetic feedback ensures maximum reliability and repeatability in the control loop over all operating conditions. Careful considerations of possible thermal stresses ensure the absence of hot spots providing long life in environments where temperature cycles are a reality. The thermal design without using any potting material allows operation at full load up to an ambient temperature of 71°C in free air, operation to 110°C with airflow. For extremely high vibration environments the case has holes for screw mounting. Inhibit or open frame mounting provide a high level of application specific engineering and design-in flexibility.

Table of Contents

	Page		Page
Description	1	Auxiliary Functions	9
Model Selection	2	Electromagnetic Compatibility (EMC)	11
Part Number Description	2	Immunity to Environmental Conditions	12
Functional Description	3	Mechanical Data	13
Electrical Input Data	4	Safety and Installation Instructions	14
Electrical Output Data	6	Description of Options	15

Model Selection

Table 1: Model Selection

Output 1		Output 2		Output 3		Output 4		Input voltage	Eff.	Model	Trim ¹	Opt. ²
V _{o nom} [VDC]	I _{o nom} [A]	V _{o nom} [VDC]	I _{o nom} [A]	V _{o nom} [VDC]	I _{o nom} [A]	V _{o nom} [VDC]	I _{o nom} [A]	V _{i min} to V _{i max} [VDC]	η _{typ} [%]			
5	1.35	5	1.35	5	1.35	5	1.35	9 to 36	86	20IMX35D05D05-8	primary	i Z -9
5	1.4	5	1.4	5	1.4	5	1.4	18 to 75	87	40IMX35D05D05-8		
5	1.4	5	1.4	5	1.4	5	1.4	40 to 121	86	70IMX35D05D05-8		
5	1.4	5	1.4	5	1.4	5	1.4	60 to 150	86	110IMX35D05D05-8		
12	0.65	12	0.65	12	0.65	12	0.65	9 to 36	86	20IMX35D12D12-8	primary	
12	0.7	12	0.7	12	0.7	12	0.7	18 to 75	88	40IMX35D12D12-8		
12	0.7	12	0.7	12	0.7	12	0.7	40 to 121	88	70IMX35D12D12-8		
12	0.7	12	0.7	12	0.7	12	0.7	60 to 150	88	110IMX35D12D12-8		
15	0.55	15	0.55	15	0.55	15	0.55	9 to 36	88	20IMX35D15D15-8	primary	
15	0.6	15	0.6	15	0.6	15	0.6	18 to 75	89	40IMX35D15D15-8		
15	0.6	15	0.6	15	0.6	15	0.6	40 to 121	88	70IMX35D15D15-8		
15	0.6	15	0.6	15	0.6	15	0.6	60 to 150	88	110IMX35D15D15-8		
5	1.35	12	0.65	12	0.65	5	1.35	9 to 36	88	20IMX35D05D12-8	primary	
5	1.4	12	0.7	12	0.7	5	1.4	18 to 75	89	40IMX35D05D12-8		
5	1.4	12	0.7	12	0.7	5	1.4	40 to 121	88	70IMX35D05D12-8		
5	1.4	12	0.7	12	0.7	5	1.4	60 to 150	88	110IMX35D05D12-8		
5	1.35	15	0.55	15	0.55	5	1.35	9 to 36	88	20IMX35D05D15-8	primary	
5	1.4	15	0.6	15	0.6	5	1.4	18 to 75	89	40IMX35D05D15-8		
5	1.4	15	0.6	15	0.6	5	1.4	40 to 121	88	70IMX35D05D15-8		
5	1.4	15	0.6	15	0.6	5	1.4	60 to 150	88	110IMX35D05D15-8		

¹ The Trim input (pin 5) on the primary side influences all outputs simultaneously on equal voltage types (e.g., D12D12) for unequal voltages (e.g., D05D12) it only influences the power train Vo1/Vo4, while Trim1 (pin 18) on the secondary side influences the first output (V_{o1}) only.

² For minimum quantity contact Power-One; not all options immediately available.

Part Number Description

20 IMX35 D05 D05 -8 i Z

Input voltage range V _i		
9 to 36 VDC	20	
18 to 75 VDC	40	
40 to 121 VDC	70	
60 to 150 VDC	110	
Series	IMX35	
Output 1 & 4 of quad types	D05, D12, D15	
Output 2 & 3 of quad types	D05, D12, D15	
Operating ambient temperature range T _A		
-40 to 71°C NFND	-9	
-40 to 85°C (110°C)	-8	
Options:		
Inhibit	-i	
Open frame	Z	
	NFND (Not for New Designs)	

Functional Description

The IMX35 family of dc-dc converters consists of two feedback controlled interleaved switching flyback power trains using current mode PWM (pulse width modulation).

The quadruple output IMX35 consists of four outputs and two power trains. Vo1, Vo4 derive from the first power train and Vo2, Vo3 from the second one (thus each pair of outputs is independent from the other one). Voltage regulation for each pair of outputs is achieved with passive transformer feedback from the main transformer of each power train. Each pair of outputs are restricted to being of the same output voltage type (i.e. D05, D12, etc.). If both power trains have the same output voltage, all outputs may be adjusted by means of the Trim input. (In case of different output voltages, the Trim1 input influences only Vo1 and Vo4. See: *Block diagram, quadruple output types.*)

The dual output types consist of two electrically isolated outputs Vo1, Vo2. Vo1 and Vo2 derives from two power trains and are electrically isolated. Voltage regulation for each output is achieved with passive transformer feedback from the main transformer of each power train. Adjustment of the outputs voltages in the range of 90 to 105% of $V_{o\ nom}$ is possible via Trim input on the primary side.

Current limitation is provided by the primary circuit for each power train and limits the possible output power for each pair of outputs. In the case of an overload on either of the power trains which causes the output voltage to fall less than typically 60% of $V_{o\ nom}$, the entire converter will shut down and automatically restart in short intervals.

Overtemperature protection is provided; this will shut down the converter in excessive overload conditions with automatic restart approximately in short intervals.

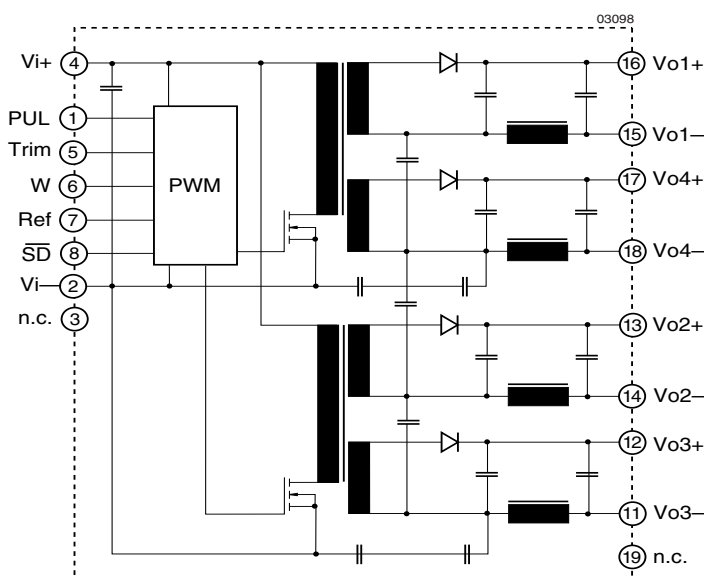

Fig. 2
Block diagram, quadruple output types

Electrical Input Data

General conditions:

$T_A = 25^\circ\text{C}$, unless T_C is specified; Shut down pin left open circuit (not connected); Trim not connected.

Table 2: Input Data

Input			20IMX			40IMX			Unit
Characteristics		Conditions	min	typ	max	min	typ	max	
V_i	Input voltage range ¹	$T_A \text{ min to } T_A \text{ max}$ $I_o = 0 \text{ to } I_o \text{ nom}$	9 ²		36	18 ²		75	VDC
$V_{i \text{ nom}}$	Nominal input voltage		20			40			
$V_{i \text{ sur}}$	Repetitive surge voltage	Abs. max input (3 s)			40			100	
$t_{\text{start up}}$	Converter start-up time ²	Switch on	0.25		0.5	0.25		0.5	s
		SD high			0.1			0.1	
t_{rise}	Rise time ³	$V_{i \text{ nom}}$ resist load	3			3			ms
		$I_o \text{ nom}$ capac. load	6	12		6	12		
$I_{i \text{ o}}$	No load input current	$I_o = 0, V_{i \text{ min}} \text{ to } V_{i \text{ max}}$			70			50	mA
I_{irr}	Reflected ripple current	$I_o = 0 \text{ to } I_o \text{ nom}$			30			30	
$I_{\text{inr p}}$	Inrush peak current ⁴	$V_i = V_{i \text{ nom}}$			8			9	A
C_i	Input capacitance	for surge calculation	2			1.3			μF
U_{SD}	Shut down voltage	Unit shut down	-10 to 0.7			-10 to 0.7			VDC
		Unit operating	open circuit or 2 to 20			open circuit or 2 to 20			
R_{SD}	Shut down input resistance	For current calculations	approx. 10			approx. 10			$\text{k}\Omega$
I_{SD}	Input current if unit shut down	$V_{i \text{ min}} \text{ to } V_{i \text{ max}}$			12			6	mA
f_s	Switching frequency	$V_{i \text{ min}} \text{ to } V_{i \text{ max}}, I_o = 0 \text{ to } I_o \text{ nom}$	approx. 220			approx. 220			
$U_{\text{i RFI}}$	Input RFI level, conducted	EN 55022 ⁵	B ⁶			B ⁶			

Input			70IMX			110IMX			Unit
Characteristics		Conditions	min	typ	max	min	typ	max	
V_i	Input voltage range ¹	$T_A \text{ min to } T_A \text{ max}$ $I_o = 0 \text{ to } I_o \text{ nom}$	40 ²		121	60 ²		150	VDC
$V_{i \text{ nom}}$	Nominal input voltage		70			110			
$V_{i \text{ sur}}$	Repetitive surge voltage	Abs. max input (3 s)			150			170	
$t_{\text{start up}}$	Converter start-up time ²	Switch on	0.25		0.5	0.25		0.5	s
		SD high			0.1			0.1	
t_{rise}	Rise time ³	$V_{i \text{ nom}}$ resist load	3			3			ms
		$I_o \text{ nom}$ capac. load	6	12		6	12		
$I_{i \text{ o}}$	No load input current	$I_o = 0, V_{i \text{ min}} \text{ to } V_{i \text{ max}}$			30			20	mA
I_{irr}	Reflected ripple current	$I_o = 0 \text{ to } I_o \text{ nom}$			30			30	
$I_{\text{inr p}}$	Inrush peak current ⁴	$V_i = V_{i \text{ nom}}$			7			7	A
C_i	Input capacitance	for surge calculation	0.5			0.5			μF
V_{SD}	Shut down voltage	Unit shut down	-10 to 0.7			-10 to 0.7			VDC
		Unit operating	open circuit or 2 to 20			open circuit or 2 to 20			
R_{SD}	Shut down input resistance	For current calculations	approx. 10			approx. 10			$\text{k}\Omega$
I_{SD}	Input current if unit shut down	$V_{i \text{ min}} \text{ to } V_{i \text{ max}}$			3.5			4	mA
f_s	Switching frequency	$V_{i \text{ min}} \text{ to } V_{i \text{ max}}, I_o = 0 \text{ to } I_o \text{ nom}$	approx. 220			approx. 220			
$U_{\text{i RFI}}$	Input RFI level, conducted	EN 55022 ⁵	B ⁶			B ⁶			

¹ $V_{i \text{ min}}$ will not be as stated if V_o is increased above $V_o \text{ nom}$ by use of Trim input. If the output voltage is set to a higher value, $V_{i \text{ min}}$ will be proportionately increased.

² Input undervoltage lockout at typ. 85% of $V_{i \text{ min}}$.

³ Measured with resistive and max. admissible capacitive load.

⁴ Source impedance according to ETS 300132-2, version 4.3.

⁵ Measured with a lead length of 0.1 m, leads twisted.

⁶ External capacitor required.

Inrush Current

The inrush current has been kept as low as possible by choosing a very small input capacitance. A series resistor may be installed in the input line to further reduce this current.

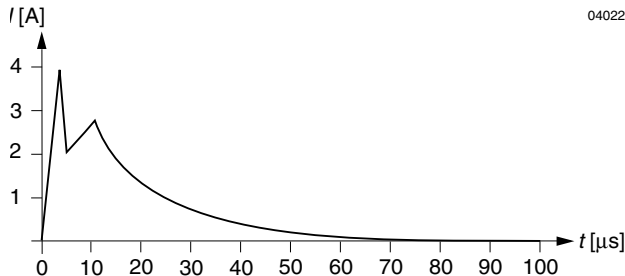

Fig. 3
Typical inrush current at $U_{i\text{ nom}}$, $P_{o\text{ nom}}$ versus time (40 IMX 35). Source impedance according to prETS 300132-2, version 4.3 at $V_{i\text{ nom}}$.

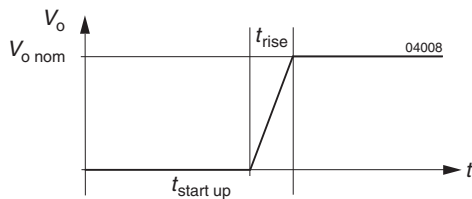

Fig. 4
Converter start-up and rise time

Reverse Polarity Protection

The built-in suppressor diode also provides for reverse polarity protection at the input by conducting current in the reverse direction. An external fuse is required to limit this current.

Table 3: Recommended external fuses

Converter type	Fuse type
20IMX35	F8.0A
40IMX35	F4.0A
70IMX35	F2.0A
110IMX35	F1.5A

Input Transient Voltage Protection

A built-in suppressor diode provides effective protection against input transients which may be caused for example by short-circuits across the input lines where the network inductance may cause high energy pulses.

Table 4: Built-in transient voltage suppressor

Type	Breakdown voltage $V_{Br\text{ nom}}$ [V]	Peak power at 1 ms P_p [W]	Peak pulse current I_{pp} [A]
20IMX35	39	1500	22
40IMX35	100	1500	9.7
70IMX35	151	600	2.9
110IMX35	176	600	2.5

For very high energy transients as for example to achieve IEC/EN 61000-4-5 or ETR 283 (19 Pfl1) compliance (as per table: *Electromagnetic Immunity*) an external inductor and capacitor are required. The components should have similar characteristics as listed in table: *Components for external circuitry for IEC/EN 61000-4-5, level 2 or ETR 283 (19Pfl1) compliance*.

Note: The suppressor diode D is only necessary for 20IMX35 types.

Table 5: Components for external circuitry for IEC/EN 61000-4-5, level 2 or ETR 283 (19Pfl1) compliance.

Type	Inductor (L)	Capacitor (C)	Diode (D)
20IMX35	22 μ H/5A	470 μ F/40 V	1.5 k E47A
40IMX35	68 μ H/2.7 A	2 x 100 μ F/100 V	-
70IMX35	100 μ H/1 A	2 x 82 μ F/200 V	-
110IMX35	150 μ H/0.8 A	2 x 82 μ F/200 V	-

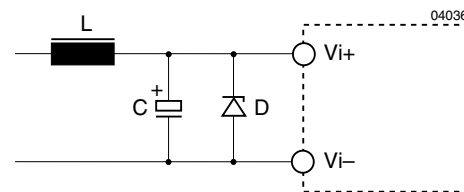

Fig. 5
Example for external circuitry to comply with IEC/EN 61000-4-5 or ETR 283 (19Pfl1); the diode D is only necessary for 20IMX35 types.

Electrical Output Data

General conditions:

- $T_A = 25^\circ\text{C}$, unless T_C is specified
- Shutdown pin left open circuit (not connected)
- Trim not connected

Table 6b: Output data for double output power trains. (V_{o1}/V_{o4} or V_{o2}/V_{o3} , i.e. each output train has two outputs)

Output			2 x 5 V			2 x 12 V			2 x 15 V			Unit
Characteristics	Conditions		min	typ	max	min	typ	max	min	typ	max	
V_{o1} V_{o2}	Output voltage		$V_{i\text{ nom}}$	4.95	5.05	11.88	12.12	14.85	15.15			VDC
			$I_o = 0.5 I_{o\text{ nom}}$	4.94	5.06	11.86	12.14	14.82	15.18			
$I_{o\text{ nom}}$	Output current	20IMX 40IMX 70IMX 110IMX	$V_{i\text{ min}}$ to $V_{i\text{ max}}$	2 x 1.35		2 x 0.65		2 x 0.55				A
				2 x 1.4		2 x 0.70		2 x 0.60				
				2 x 1.4		2 x 0.70		2 x 0.60				
				2 x 1.4		2 x 0.70		2 x 0.60				
I_{oL}	Current limit ¹	20IMX 40IMX 70IMX 110IMX	$V_{i\text{ nom}}, T_C = 25^\circ\text{C}$ $V_o = 93\% V_{o\text{ nom}}$	3.5		1.8		1.5				
				3.8		2.0		1.7				
				3.8		2.0		1.7				
				3.8		2.0		1.7				
ΔV_{oU}	Line regulation		$V_{i\text{ min}}$ to $V_{i\text{ max}}, I_{o\text{ nom}}$	± 1		± 1		± 1				%
ΔV_{oI}	Load regulation		$V_{i\text{ nom}}$ $I_o = (0.1 \text{ to } 1) I_{o\text{ nom}}$	± 3		± 3		± 3				
$V_{o1/2}$	Output voltage noise		$V_{i\text{ min}}$ to $V_{i\text{ max}}$ $I_o = I_{o\text{ nom}}$	80		120		150				mV _{pp}
				40		60		70				
V_{oL}	Output overvoltage limit. ⁴		Min. load 1%	115	130	115	130	115	130			%
$C_{o\text{ ext}}$	Admissible capacitive load			4000		470		330				μF
$V_{o\text{ d}}$	Dynamic load regulation	Voltage deviat.	$V_{i\text{ nom}}$	± 250		± 480		± 520				mV
t_d		Recovery time	$I_{o\text{ nom}} \times 1/2 I_{o\text{ nom}}$	0.75		0.75		0.75				ms
a_{V_o}	Temperature coefficient $\Delta V_o / \Delta T_C$		$V_{i\text{ min}}$ to $V_{i\text{ max}}$ $I_o = 0$ to $I_{o\text{ max}}$	± 0.02		± 0.02		± 0.02				%/K

¹ The current limit is primary side controlled. In the event of a sustained overload condition the thermal protection may cause the unit to shutdown (restart on cool-down).

² BW = 20 MHz

³ Measured with a probe according to EN 61204

⁴ The overvoltage protection is via a primary side second regulation loop, not tracking with Trim control.

Thermal Considerations

If a converter, mounted on a PCB, is located in free, quasi-stationary air (convection cooling) at the indicated maximum ambient temperature $T_{A\max}$ (see table: *Temperature specifications*) and is operated at its nominal input voltage and output power, the case temperature T_C measured at the *Measuring point of case temperature* T_C (see: *Mechanical Data*) will approach the indicated value $T_{C\max}$ after the warm-up phase. However, the relationship between T_A and T_C depends heavily on the conditions of operation and integration into a system. The thermal conditions are influenced by input voltage, output current, airflow, temperature of surrounding components and the surfaces and properties of the printed circuit board. $T_{A\max}$ is therefore only an indicative value and under practical operating conditions, the ambient temperature T_A may be higher or lower than this value.

Caution: The case temperature T_C measured at the: *Measuring point of case temperature* T_C (see: *Mechanical Data*) may under no circumstances exceed the specified maximum value. The installer must ensure that under all operating conditions T_C remains within the limits stated in the table: *Temperature specifications*.

Version -8

Extended Temperature Range

Extension of the temperature range from standard -40 to 71°C to -40 to 85°C (up to 110°C). The modules will provide the specified output power with free air convection cooling. In the upper temperature range the output power derating below should be observed.

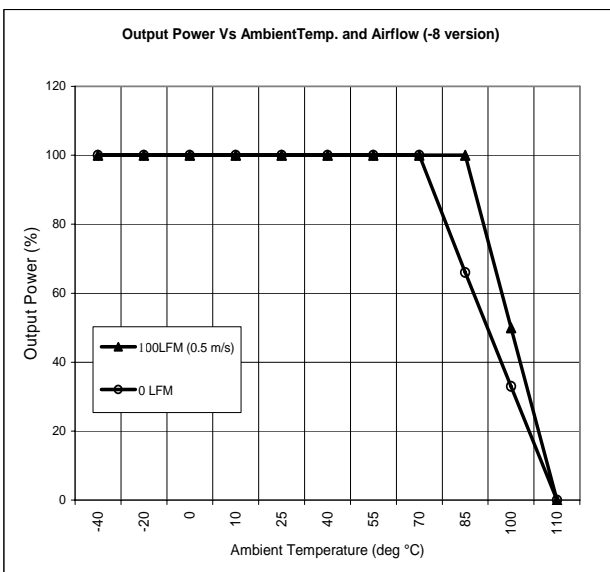

Fig. 6
Maximum allowed output power versus ambient temperature.

Short Circuit Behavior

The current limit characteristic shuts down the converter whenever a short circuit is applied to an output. It acts self-protecting and automatically recovers after removal of the overload condition (hiccup mode).

Overtemperature Protection

The converter is protected against possible overheating by means of an internal temperature monitoring circuit. It shuts down the unit above the internal temperature limit and attempts to automatically restart. This feature prevents excessive internal temperature building up which could occur under heavy overload conditions.

Connection in Series

The outputs of one or several single or double output power trains may be connected in series without any precautions.

Connection in Parallel

Several outputs of the same converter with equal output voltage (e.g. 5V / 5V) can be put in parallel and will share their output currents almost equally.

If outputs from the same unit are being paralleled together it is recommended that outputs from the same power trains are connected together first.

NOTE: A separate application note is available for uses when all outputs are paralleled together.

Parallel operation of several converters with the same output voltage may cause start-up problems at initial start-up. This is only advisable in applications where one converter is able to deliver the full load current as is required in true redundant systems. It is recommended not to parallel more than three units at full load.

Typical Performance Curves

General conditions:

- $T_A = 25^\circ\text{C}$, unless T_C is specified.
- Shut down pin left open circuit.
- Trim input not connected.

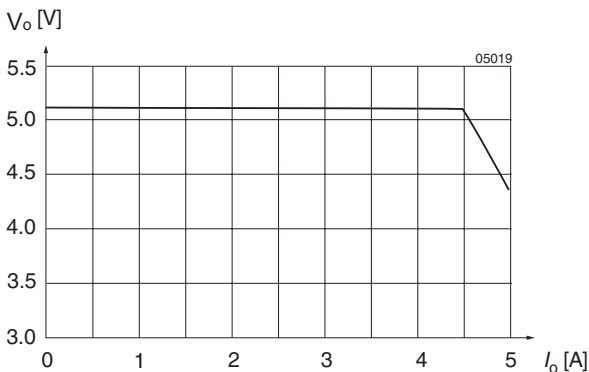

Fig. 7
 V_o versus I_o (typ) of units with $V_o = 5.1$ V.
(40IMX35-05D12-9).

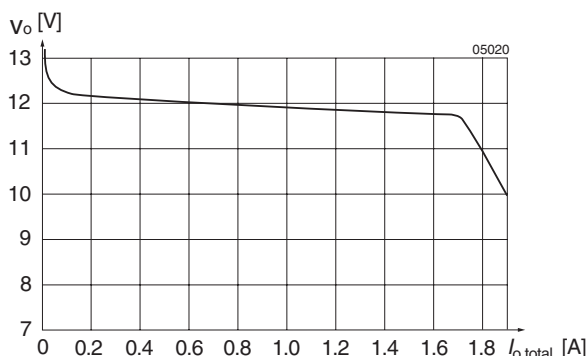

Fig. 8
 $U_{o1/2}$ versus $I_{o1/2}$ of double output power trains
(i.e. 2×12 V). See: Block diagram 1

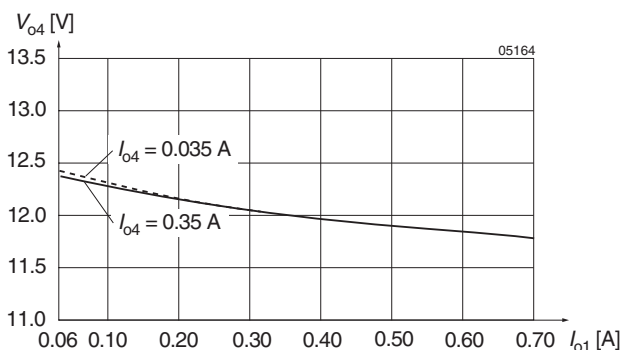

Fig. 9
Cross load regulation V_{o4} versus I_{o1} (typ) for various I_{o4}
for $Vo1$, $Vo4$ on power train 1. See: Block diagram dual
output types. (20IMX35D12D12-9)

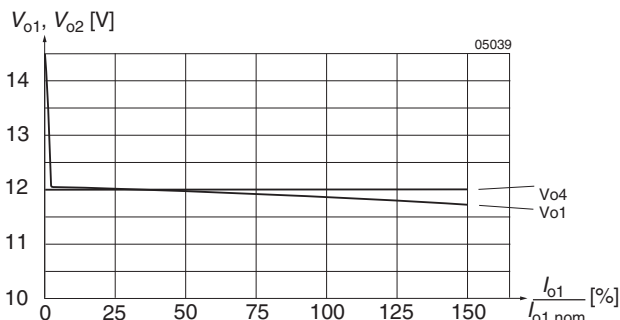

Fig. 10
Flexible load distribution on power train 1 of
40IMX35D12D12-9 (4 x 12 V) with load variation from 0 to
150% of $P_{o1 nom}$ on output 1 ($Vo1$). Output 2 ($Vo4$) loaded
with 50% of $P_{o4 nom}$.

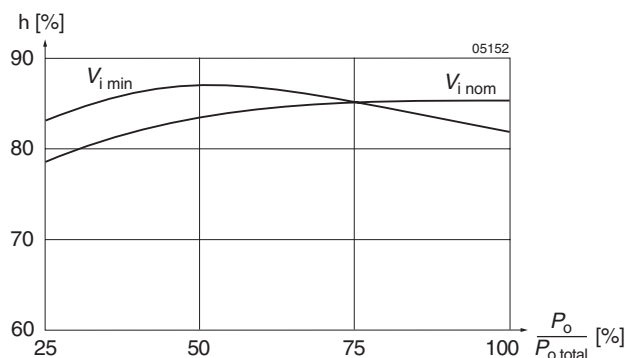

Fig. 11
Efficiency versus input voltage and load. Typical values
40IMX35D12D12-9

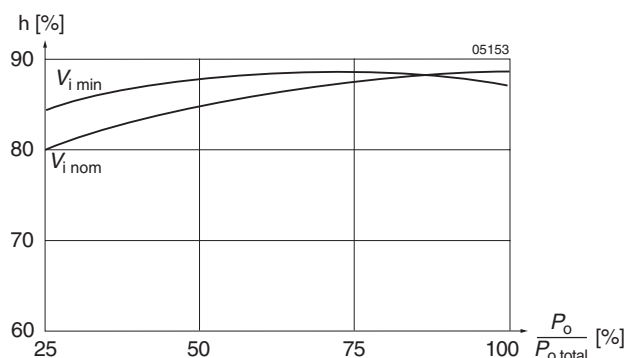

Fig. 12
Efficiency versus input voltage and load. Typical values
20IMX35D12D12-9

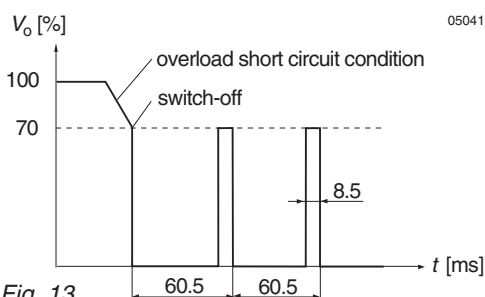

Fig. 13
Overload switch off (hiccup mode), typical values.

Auxiliary Functions

Adjustable Output Voltage

As a standard feature, the IMX35 offers adjustable output voltages in the range of 90 to 105% of $V_{o,nom}$ by use of a control pin. The Trim control is offered either on primary or secondary side of the converter depending on type.

Quad Output Adjustment

The quadruple output units are shown in block diagram (fig. 2). All types with equal output voltage have the Trim function connected to pin 5 referenced to the primary side which influences all outputs simultaneously. The schematics are shown in fig. 15, the values of the adjust resistor R_{ext} in Table 8 and the external voltage source in Table 9.

Adjustment by means of an external resistor R_{ext} :

Adjustment of the output voltage by means of an external resistor R_{ext} is possible within the range of 100 to 105% of $V_{o,nom}$. R_{ext} should be connected between Trim (pin 5) and V_{i-} (pin 2). Connection of R_{ext} to V_{i+} may damage the converter. The following table indicates suitable resistor values for typical output voltages under nominal conditions ($V_{i,nom}$, $I_o = 0.5 I_{o,nom}$).

Table 8: R_{ext1} for $V_o > V_{o,nom}$; approximate values ($V_{i,nom}$, $I_o = 0.5 I_{o,nom}$)

V_o [% $V_{o,nom}$]	R_{ext} [kΩ]	
	Trim [kΩ]	Trim 1/4 [kΩ]
105 to 108 (107 typically)	0	0
105	10	17
102	62	110
100	:	:

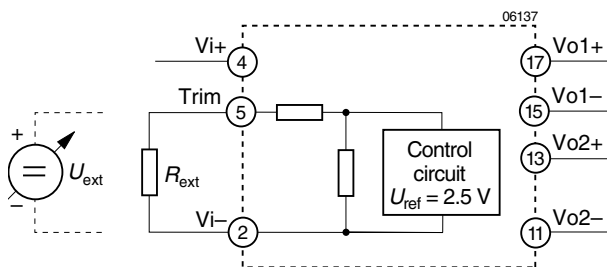

Fig. 15 Output voltage control for Quad (double) output units by means of the Trim input on the primary side.

Adjustment by means of an external voltage source V_{ext}

For external output voltage adjustment in the range 85 to 105% of $V_{o,nom}$ a (0 to 20 V) source V_{ext} is required, connected to the Trim (pin 5) and V_{i-} . The table below indicates typical V_o versus V_{ext} values. Applying a control voltage of 15 to 20 V will set the converter into a hiccup mode. Direct paralleling of the Trim pins of units of the same type connected in parallel is feasible.

Table 9: V_o versus V_{ext} for $V_o = 85$ to 105% $V_{o,nom}$; typical values ($V_{i,nom}$, $I_o = 0.5 I_{o,nom}$)

V_o [% $V_{o,nom}$]	V_{ext} [V]	
	Trim [V]	Trim 1/4 [V]
>105	0	0
102	1.8	1.5
100	2.5	2.5
95	4.3	4.25
90	6.2	6.2
85	8	8

Synchronization (W)

It is possible to synchronise the switching frequency of one or more converters to an external symmetrical clocksignal. Consult factory if this option is required, for full application details.

This logic input can be used to synchronise the oscillator to an external frequency source. This pin is edge triggered with TTL thresholds, and requires a source frequency of 490 to 540 kHz (duty cycle 10 to 90%). The external source frequency is internally divided by 2 to define the switching frequency for the converter. If unused, this pin can be connected to V1- (pin 2) or left open-circuit.

Reference (Ref)

The signal output provides a stable 5 V (± 0.1 V) reference signal on pin Ref. It is protected by a 1 kW resistor. This signal may be used also in conjunction with the Trim input pin 5 (primary side) as a limited external voltage reference.

It is recommended to connect a filter capacitor (0.1 mF) between Ref and Vi-, if V_{ref} is used.

Shut Down Function

The outputs of the converters may be enabled or disabled by means of a logic signal (TTL, CMOS, etc.) applied to the shut down pin. If the shut down function is not required, then it should be left open-circuit.

Converter operating: 2.0 to 20 V
Converter shut down: -10 to 0.7 V

Option i

Inhibit (negative shutdown logic)

The output of the converter may be enabled or disabled by means of a logic signal (TTL, CMOS, etc.) applied to the inhibit pin. No output voltage overshoot will occur when the unit is turned on. If the inhibit function is not required the inhibit (pin 8) should be connected to Vi- to enable the output (active low logic, fail safe).

Converter operating: -10 V to 0.8 V
Converter inhibited
or inhibit pin left open circuit: 2.4 V to 20 V

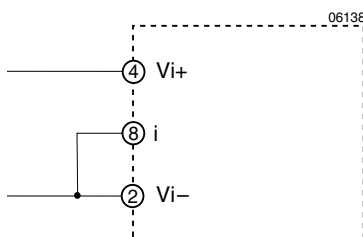

Fig. 16
If the inhibit is not used the inhibit pin should be connected to Vi-

Programmable Input Undervoltage Lockout PUL

A special feature of these units is the accurate undervoltage lockout protection which protects the unit (and the system) from large currents caused by operation at low voltages. This ensures easier start-up in distributed power systems.

Table 10: Turn on and turn off voltage

Type	Trigger level	Hysteresis	Units
20IMX35	7 to 8	<0.5	V
40IMX35	14 to 15.5	<1	
70IMX35	31 to 34	<3	
110IMX35	42 to 50	<8	

See: *Electrical input data* for a description of the turn on turn off voltage levels of the various types.

The under voltage lockout levels may be programmed by use of an external resistor to Trim up the preset levels as indicated in the table below.

Table 11: Typical values for R_{ext} and the respective lockout voltage for input voltage.

20IMX35		40IMX35	
R _{PUL} [kΩ]	V _{i min} [V]	R _{ext} [kΩ]	V _{min} [V]
:	≤8	:	≤15.5
39	10	43	22
19	12	16	26
13	14	10	28
9.1	16	0	32

70IMX35		110IMX35	
R _{PUL} [kΩ]	V _{i min} [V]	R _{ext} [kΩ]	V _{min} [V]
:	31	:	42
270	40	270	50
110	50	120	60
80	55	51	75

Electromagnetic Compatibility (EMC)

A suppressor diode together with an input filter form an effective protection against high input transient voltages which typically occur in many installations, but especially in battery-driven mobile applications.

Electromagnetic Immunity

Table 12: Immunity type tests

Phenomenon	Standard ¹	Class Level	Coupling mode ²	Value applied	Waveform	Source Imped.	Test procedure	In oper.	Per- ³ form.	
Electrostatic discharge to case	IEC/EN 61000-4-2	2	contact discharge (R pin open)	4000 V _p	1/50 ns	330 Ω	10 positive and 10 negative discharges	yes	B	
		3	air discharge (R pin open)	8000 V _p						
Electromagnetic field	IEC/EN 61000-4-3	3	antenna	10 V/m	AM 80% 1 kHz		26 to 1000 MHz	yes	A	
	ENV 50204				PM, 50% duty cycle, 200 Hz resp. frequ.		900 MHz			
Electrical fast transient/burst	IEC/EN 61000-4-4	4	direct +i/-i	4000 V _p	bursts of 5/50 ns 5 kHz rep. rate transients with 15 ms burst duration and a 300 ms period	50 Ω	1 min positive 1 min negative transients per coupling mode	yes	B	
Surge	IEC/EN 61000-4-5 ⁴	3	+i/-i	2000 V _p	1.2/50 μs	2 Ω	5 pos. and 5 neg. impulses per coupling mode	yes	B	
	EN 50155			D	1800V	5/50 μs	100 Ω	triangular	yes	B
				G	8400V	.05/01 μs				
Conducted disturbances	IEC/EN 61000-4-6	3	+i/-i	10 V _{rms} (140 dBμV)	AM modulated 80%, 1 kHz	50 Ω	0.15 to 80 MHz 150 Ω	yes	A	

¹ Related and previous standards are referenced in: *Technical Information: Standards.*

² i = input, o = output.

³ A = normal operation, no deviation from specification, B = temporary deviation from specs. possible.

⁴ External components required.

Electromagnetic Emission

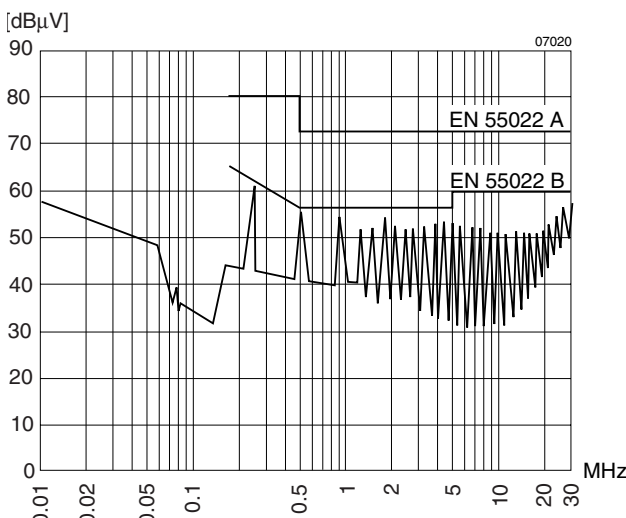

Fig. 17
Typical disturbance voltage (quasi-peak) at the input according to CISPR 11/EN 55011 and CISPR 22/EN 55022, measured at U_{i,nom} and I_{o,nom}. Output leads 0.1 m, twisted. (40IMX35D12D12-9)

CISPR 22/EN 55022, Level B Radiated

Electromagnetic emission requirements according to EN 55022, class B (radiated) can be achieved by adding an external common mode choke and (for 20 IMX 35 types) an additional capacitor, see: *Input Data*. The filter components should be placed as close as possible to the input of the converter.

Table 13: Input filter components for EN 55022, level B, radiated.

Type	Current compensated choke
20IMX35	Murata PLH1OA series 7003R6P02
40IMX35	Murata PLH1OA series 1612R1P02
70IMX35	Murata PLH1OA series 2911R2P02
110IMX35	Murata PLH1OA series 3711R0P02

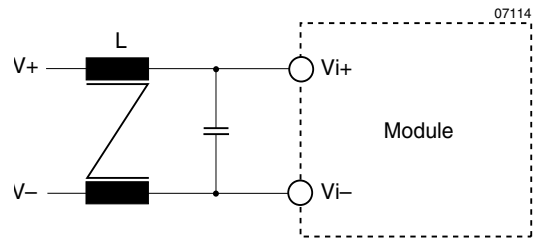

Fig. 18
Example for external circuitry to comply with CISPR22/EN 55022, level B, radiated

Immunity to Environmental Conditions

Table 14: Temperature specifications, valid for air pressure of 800...1200 hPa (800...1200 mbar)

Temperature		-8 ³		Unit
Characteristics	Conditions	min	max	
T _A Ambient temperature ¹	Operational ²	-40	85 ²	°C
T _C Case temperature		-40	110	
T _S Storage temperature ¹	Non operational	-55	110	

¹ MIL-STD-810D section 501.2 and 502.2

² See: *Thermal Considerations*

³ Start up at -55°C

Table 15: MTBF and device hours

MTBF (Standard)	Ground Benign	Ground Fixed		Ground Mobile
40 IMX 35 (MIL-HDBK-217F)	336,000 hrs (T _C = 40°C)	141,000 (T _C = 40°C)	86,000 (T _C = 70°C)	110,000 (T _C = 50°C)
110 IMX 35 (Bellcore)	1,372,000 hrs @ 25°C at 100% load			

Table 16: Environmental testing

Test Method	Standard	Test Conditions		Status
Ca Damp heat steady state	IEC/DIN IEC 60068-2-3 MIL-STD-810D section 507.2	Temperature: 40 ±2 °C Relative humidity: 93 ^{+2/-3} % Duration: 56 days		Unit not operating
Ea Shock (half-sinusoidal)	IEC/EN/DIN EN 60068-2-27 MIL-STD-810D section 516.3	Acceleration amplitude: 100 g _n = 981 m/s ² Bump duration: 6 ms Number of bumps: 18 (3 each direction)		Unit operating
Eb Bump (half-sinusoidal)	IEC/EN/DIN EN 60068-2-29 MIL-STD-810D section 516.3	Acceleration amplitude: 40 g _n = 392 m/s ² Bump duration: 6 ms Number of bumps: 6000 (1000 each direction)		Unit operating
Fc Vibration (sinusoidal)	IEC/EN/DIN EN 60068-2-6	Acceleration amplitude: 0.35 mm (10 to 60 Hz) 5 g _n = 49 m/s ² (60 to 2000 Hz) Frequency (1 Oct/min): 10 to 2000 Hz Test duration: 7.5 h (2.5 h each axis)		Unit operating
Fh Vibration broad-band random (digital control)	IEC/EN 60068-2-64 MIL-STD-810D section 514.3	Acceleration spectral density: 0.05 g _n ² /Hz Frequency band: 20 to 500 Hz Acceleration magnitude: 4.9 g _{n rms} Test duration: 3 h (1 h each axis)		Unit operating
Kb Salt mist, cyclic (sodium chloride NaCl solution)	IEC/EN/DIN IEC 60068-2-52	Concentration: 5% (30°C) Duration: 2 h per cycle Storage: 40°C, 93% rel. humidity Storage duration: 22 h per cycle Number of cycles: 3		Unit not operating

Mechanical Data

Dimensions in mm. Tolerances ± 0.3 mm unless otherwise indicated.

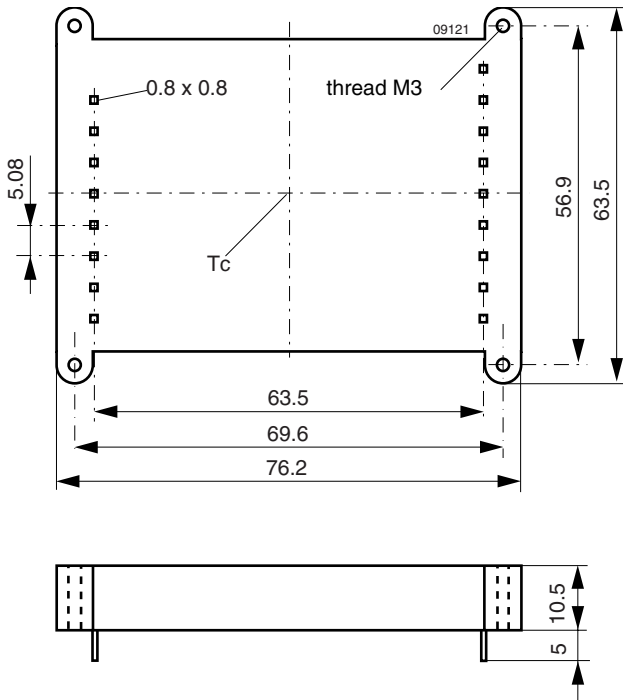

Fig. 19
Case IMX35 (Standard)
Weight: 67 g

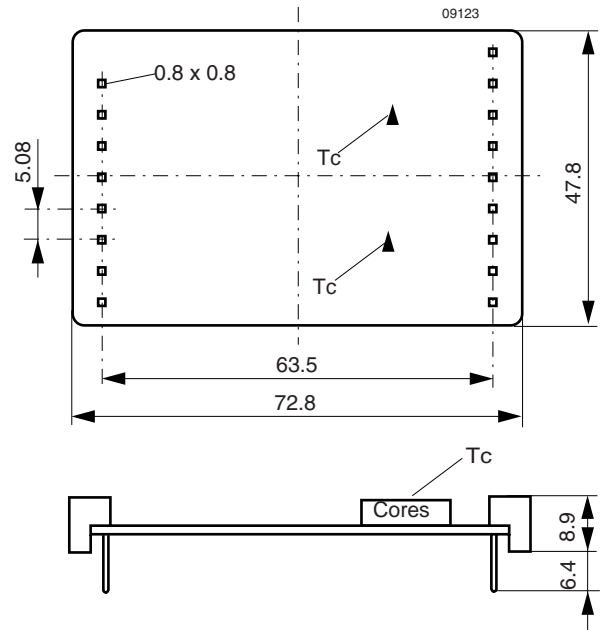

Fig. 20
Case IMX35 open frame (option Z)
Weight: 43 g

Safety and Installation Instructions

Installation Instructions

Installation of the dc-dc converters must strictly follow the national safety regulations in compliance with the enclosure, mounting, creepage, clearance, casualty, markings, and segregation requirements of the end-use application.

Connection to the system shall be made via a printed circuit board with hole diameters of 1.5 mm for the pins.

The units should be connected to a secondary circuit.

Check for hazardous voltages before altering any connections.

Do not open the module.

Ensure that a unit failure (e.g., by an internal short-circuit) does not result in a hazardous condition. See also: *Safety of operator accessible output circuit.*

Input Fuse

To prevent excessive current flowing through the input supply line in case of a short-circuit across the converter input an external fuse should be installed in a non-earthed input supply line. We recommend a fast acting fuse F8.0A for 20IMX35 types, F4.0 A for 40IMX35 types, F2.0 A for 70IMX35 types and F2.0 A for 110IMX35 types.

Standards and approvals

All dc-dc converters are pending to be UL recognized according to UL 1950, UL recognized for Canada to CAN/CSA C22.2 No. 950-95 and LGA approved to IEC/EN 60950 standards.

The units have been evaluated for:

- Building in
- Basic insulation input to output, based on their maximum input voltage
- The use in a pollution degree 2 environment
- Connecting the input to a secondary circuit which is subject to a maximum transient rating of 1500 V

After approvals, the dc-dc converters are subject to manufacturing surveillance in accordance with the above mentioned UL, CSA, EN and with ISO 9001 standards.

Table 17: Electric strength test voltages

Characteristic	Input to output	Output to	Unit
	IMX35	output	
Electric strength test voltage 1 s	1.2		kV _{rms}
	1.5	0.2	kVDC
Insulation resistance at 500 VDC	>100	-	MΩ
Partial discharge extinction voltage	Consult factory	-	kV

Table 18: Pin allocation

Pin No.	Quadruple output
1	PUL
2	Vi-
3	n.c.
4	Vi+
5	Trim or Trim1
6	W
7	Ref
8	\overline{SD} or i
11	Vo3-
12	Vo3+
13	Vo2+
14	Vo2-
15	Vo1-
16	Vo1+
17	Vo4+
18	Vo4-
19	n.c.

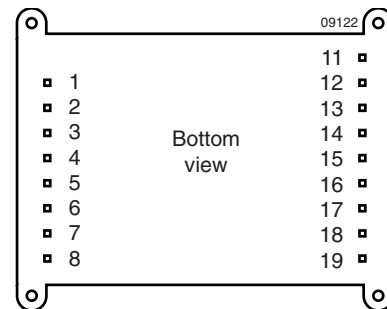

Fig. 21
Pin allocation

Protection Degree

The protection degree of the dc-dc converters is IP 30 (not for option Z).

Cleaning Agents

In order to avoid possible damage, any penetration of cleaning fluids should be prevented, since the power supplies are not hermetically sealed.

However, open cased units (option Z) which leave the factory unlacquered may be cleaned and lacquered by the customer.

Description of Options

Table 20: List of options

Option	Function of option	Characteristic
-9	Temperature range (NFND)	$T_A = -40$ to 71°C , without airflow
i	Inhibit	-
Z	Open frame	-

NFND (Not for New Designs)

NUCLEAR AND MEDICAL APPLICATIONS - Power-One products are not designed, intended for use in, or authorized for use as critical components in life support systems, equipment used in hazardous environments, or nuclear control systems without the express written consent of the respective divisional president of Power-One, Inc.

TECHNICAL REVISIONS - The appearance of products, including safety agency certifications pictured on labels, may change depending on the date manufactured. Specifications are subject to change without notice.