

### Heavy-duty Miniature Relay

- Variety of contact forms: SPDT or SPST-NO (continuous current rating: 8 A)
- Mechanical and electrical characteristics comply with EN61810-1.
- Satisfies EN60335-1 requirements with a dielectric strength of 4 kV at a distance of 8 mm.
- Tracking resistance: CTI>250



RoHS Compliant Refer to pages 16 to 17 for details.



### Ordering Information

Classification	Enclosure ratings	Contact material	Contact form	
			SPST-NO	SPDT
Standard	Fully sealed	Ag Alloy + gold plating (0.35 μ)	G6RN-1A	G6RN-1
		Ag Alloy + gold plating (4 μ)	G6RN-1A-AP4	G6RN-1-AP4

**Note:** When ordering, add the rated coil voltage to the model number.

Example: G6RN-1A 24 VDC  
└───┘ Rated coil voltage

### Model Number Legend

G6RN-□□-□□ VDC  
1 2 3 4

#### 1. Number of Poles

1: 1 pole

#### 2. Contact Form

None: SPDT

A: SPST-NO

#### 3. Contact Material

None: Ag Alloy + gold plating (0.35 μ)

AP4: Ag Alloy + gold plating (4 μ)

#### 4. Rated Coil Voltage

5, 12, 24, 48 VDC

# Specifications

## ■ Coil Ratings

Rated voltage	5 VDC	12 VDC	24 VDC	48 VDC
Rated current	43.9 mA	18.3 mA	9.2 mA	5.2 mA
Coil resistance	114 Ω	655 Ω	2,620 Ω	9,210 Ω
Must operate voltage	70% max. of rated voltage			
Must release voltage	10% min. of rated voltage			
Max. voltage	150% of rated voltage (at 23°C)			
Power consumption	Approx. 220 mW			Approx. 250 mW

Note: 1. The rated current and coil resistance are measured at a coil temperature of 23°C with a tolerance of ±10%.  
2. Operating characteristics are measured at a coil temperature of 23°C.

## ■ Contact Ratings

Load	Resistance load (cos φ = 1)
Rated load	8 A at 250 VAC; 5 A at 30 VDC
Rated carry current	8 A
Max. switching voltage	250 VAC; 30 VDC, (400 VAC) (See note.)
Max. switching current	AC 8 A; DC 5 A
Max. switching power	2,000 VA; 150 W
Failure rate (reference value)	5 VDC 10 mA (for gold plating 0.35 μ min.)

Note: P level: λ<sub>60</sub> = 0.1 × 10<sup>-6</sup> operations

## ■ Characteristics

Operate time	Max. 15 ms (Typ. 6 ms)
Release time	Max. 5 ms (Typ. 3 ms)
Max. operating frequency	Mechanical: 36,000 operations/hr Electrical: 360 operations/hr (under rated load)
Insulation resistance	1,000 MΩ min. (at 500 VDC)
Dielectric strength	4,000 VAC between coil and contacts 1,000 VAC between contacts
Creepage/clearance	8 mm min. between coil and contacts
Vibration resistance	Malfunction: NO: 10 to 55 to 10 Hz, 0.75-mm single amplitude (1.5-mm double amplitude) NC: 10 to 55 to 10 Hz, 0.4-mm single amplitude (0.8-mm double amplitude)
Shock resistance	Destruction: 1,000 m/s <sup>2</sup> Malfunction: NO: 100 m/s <sup>2</sup> NC: 50 m/s <sup>2</sup>
Endurance	Mechanical: 10,000,000 operations min. Electrical: 50,000 operations (Typ. 100,000 operations)
Ambient temperature	Operating: -40°C to 85°C (with no icing)
Ambient humidity	Operating: 5% to 85%
Weight	Approx. 9 g
Protection class	II according to VDE0106 Part 1
Insulation class	C/250, B/380 according to VDE0110

## ■ Approved Standards

### VDE (EN61810-1)

Contact form	Coil ratings	Contact ratings
SPDT SPST-NO	5, 6, 12, 18, 24, 36, 48 VDC	8 A at 250 VAC (cosφ = 1)

### UL508 (File No. E41515)

Coil rating	Contact rating
5 to 48 VDC	10 A at 250 VAC (resistive) 5 A at 30 VDC (resistive) 8 A at 250 VAC (resistive) (ambient temperature: 85°C)

CSA C22.2 (File No. LR31928-543)

Coil rating	Contact rating
5 to 48 VDC	10 A at 250 VAC (resistive) 5 A at 30 VDC (resistive) 8 A at 250 VAC (resistive) (ambient temperature: 85°C)

## Engineering Data

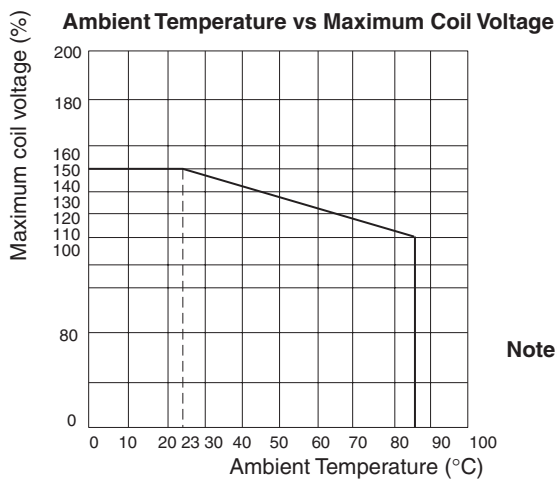
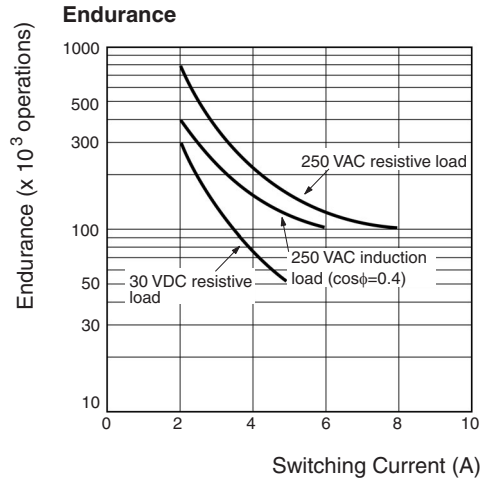
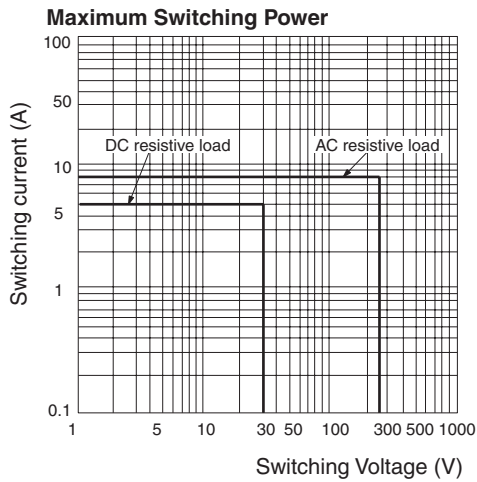

**Note:** The maximum coil voltage refers to the maximum value in a varying range of operating power voltage, not a continuous voltage.

# Dimensions

**Note:** All units are in millimeters unless otherwise indicated.

## SPDT Type

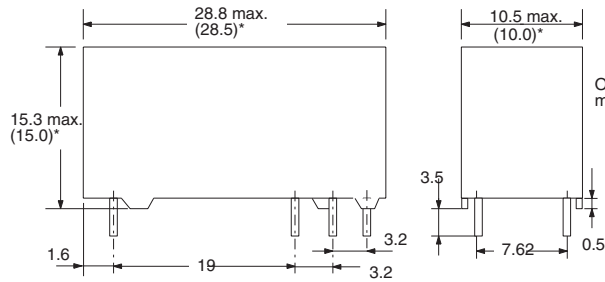
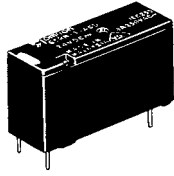

\*Average value.

### Terminal Arrangement/ Internal Connections (Bottom View)

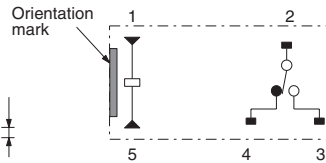

### Mounting Holes (Bottom View)

Tolerance:  $\pm 0.1$

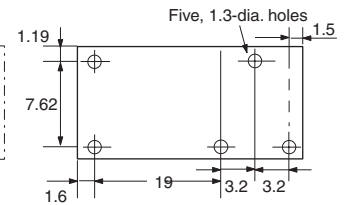

## SPST-NO Type

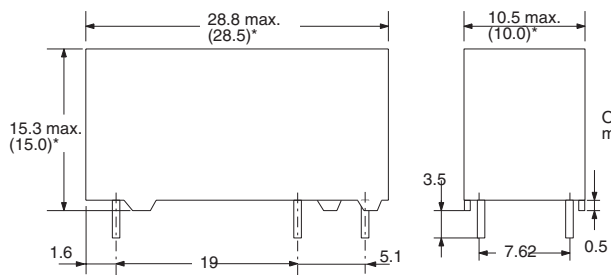
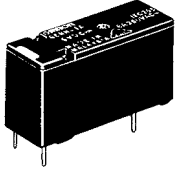

\*Average value.

### Terminal Arrangement/ Internal Connections (Bottom View)

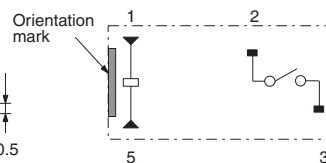

### Mounting Holes (Bottom View)

Tolerance:  $\pm 0.1$

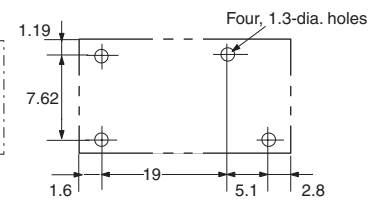

**ALL DIMENSIONS SHOWN ARE IN MILLIMETERS.**

To convert millimeters into inches, multiply by 0.03937. To convert grams into ounces, multiply by 0.03527.